

# IMPORT CATALOG



**MARINE**  
**HARDWARE**  
INC.

Global Facilitator and Supplier to the Marine Industry

# LIMITED WARRANTY & DISCLAIMER OF WARRANTY

Marine Hardware™, Inc. (Herein called "Marine Hardware") warrants the products described herein and manufactured by Marine Hardware to be free from defects in material and workmanship for a period of ONE (1) YEAR LIMITED WARRANTY from date of shipment by Marine Hardware, under normal use and service, its sole obligation under warranty being limited to repairing and replacing, (as hereinafter provided) at its option, any product found to Marine Hardware's satisfaction to be defective upon examination of it, provided that such product shall be returned for inspection, freight prepaid, to Marine Hardware's factory within 90 days after discovery of the defect.

The repair or replacement of defective products will be made without charge for parts or labor.

This warranty shall not apply to parts or products not manufactured by Marine Hardware, the warranty for such items being limited to the actual warranty extended to Marine Hardware by its supplier.

This warranty shall not apply to any product which has been subjected to abuse, negligence, accident, improperly installed, or misapplication, or to any product which shall have been altered or repaired by others than Marine Hardware, nor to normal maintenance services and the replacement of service items (such as, but not limited to: washers, gaskets, lubricants, etc.) made in connection with such purchases.

This limited warranty does not cover problems caused by improper maintenance, storage, cradling, blocking, normal wear and tear, lack of bonding or cathodic protection, misuse, neglect, accident, corrosion, electrolysis, or improper operation.

TO THE MAXIMUM EXTENT PERMITTED BY APPLICABLE LAW, MARINE HARDWARE DISCLAIMS ALL OTHER WARRANTIES, EITHER EXPRESSED OR IMPLIED, ARISING BY OPERATION OF LAW, COURSE OF DEALING, CUSTOM AND PRACTICE OR OTHERWISE, INCLUDING, BUT NOT LIMITED TO IMPLIED WARRANTIES OF MERCHANTABILITY AND FITNESS FOR A PARTICULAR PURPOSE. This limited warranty gives the purchaser specific rights that vary from state to state or from jurisdiction to jurisdiction.

To the maximum extent permissible by applicable law, in no event shall Marine Hardware be liable for any damages whatsoever (including, without limitation: special, incidental, consequential or indirect damages for personal injury, loss of business profits, business interruption, loss of business information, or any other pecuniary loss) arising out of the use or inability to use the products described herein, even if Marine Hardware has been advised of the possibility of such damages. Because some states or jurisdictions do not allow the exclusion of limitation of liability for consequential or incidental damages, the above limitation may not apply to the purchaser.

IT IS THE RESPONSIBILITY OF THE BUYER TO STUDY THE PARTICULAR HYDRODYNAMICS AND MECHANICAL NEEDS OF THEIR BOATS AND EVALUATE MARINE HARDWARE'S PRODUCTS FOR FITNESS AND APPLICABILITY THROUGH A TESTING PROGRAM AS MAY BE NECESSARY.

THE BUYER ACKNOWLEDGES THAT NO OTHER REPRESENTATIONS, AGREEMENTS, GUARANTEES, OR WARRANTIES, WRITTEN OR ORAL, WHICH ARE NOT EXPRESSED HEREIN, WERE MADE TO HIM OR HER OR RELIED UPON BY THE BUYER WITH RESPECT TO THE QUALITY, COMPOSITION, DESIGN, AND FUNCTION OF THE GOODS.

# Table of Contents

## 4-20 PLUMBING

4 Service Parts  
6 Valves  
7-11 Thru-Hulls  
10 High Speed Water Pickups  
10 Pick Up Screens  
10 Pipe Nipples  
11 Multi Port Thru-Hulls  
11 Stainless Clad Drain Tube  
11 Drain Flange  
11 Faucet  
12 Universal Swivel Mount Sea Strainers  
12 Top View Multi-Port Sea Strainers  
12 Sea Strainer Replacement Parts  
13 Straight Pipe-to-Hose Adapters  
13 Male 90° Pipe-to-Hose Adapters  
13 Female 90° Pipe-to-Hose Adapters  
14 90° Fuel Fittings  
14 Straight Fuel Fittings  
14 Hose Clamps  
15 Flush Vents  
15 Clam Vents  
16 Generator Exhaust Ports  
16 Cut Pipe Exhaust Outlet  
16 Turn Down Exhaust Outlet  
17 Nylon Exhaust Outlet  
17 Battery Box  
18-19 Garboard Drains  
20 Hose Clamps  
20 Nylon Wire Ties

## 21-25 LIGHTING

22 4" Underwater Lights  
23 2" Underwater Lights  
24 LED Courtesy Lights  
24 LED Strip Lights  
25 Custom Lighted Logos/Letters

## 27-58 DECK HARDWARE

28 Dual Post Pull-Up Cleats  
28 Single Post Pull-Up Cleats  
29 Stud Mount Pull-Up Cleats  
29 Hole Mount Pull-Up Cleats  
29 Fender Cleat, Pull-Up  
29 Retractable Fender Cleat

30 Stud Mount Euro Cleats  
30 Feet Mount Euro Cleats  
30 EVT Cleats  
31 Hollow Base Cleats  
31 Heavy Duty Hollow Base Cleat  
31 Stud Mount Hollow Base Cleat  
31 Chrome Plated Hollow Base Cleat  
32 Custom Cleats  
32 Chocks  
33 Single Head Bollards  
33 Dual Horn Bollards  
33 Two Horn Fabricated Bollards  
34 Lifting Rings/Cleats  
34 Keel Plates  
34 Lifting Rods  
34 Vector Lifting Eye  
34 Flush Transom Eye  
35 Bow Eyes  
35 Stern Eyes  
35 Bow Plate w/Bow Eye  
36 Large Oval Hawse Pipe  
36 Small Oval Hawse Pipe  
36 Hawse Pipes  
36 Hawse Cleats & Rings  
37 Scuppers  
37 Custom Drain Scuppers  
37 Chain & Rope Deck Pipe  
38 Deck Fills with Key  
38 Toggle Cap Deck Fills  
39 Hand Cap Deck Fills  
39 Angle Neck Deck Fills  
39 Short Deck Fills  
40 Deck Fill Replacement Parts  
40 Deck Plates  
40 Washdown Deck Plate  
41 Drink Cup Holders  
42-43 Grab Rails/Handles  
43 Cabinet Handles  
43 Fiddle Rails  
44-46 Rod Holders  
46 Weldable Rail Bases-Stamped 316SS  
47 Weldable Rail Bases-Cast  
48-49 Rail Fittings  
50 Top Caps  
50 Pad Eyes

50 Top Slides  
50 Deck Hinges  
51 Pull Pins  
51 Stand Offs  
51 Pelican Hooks  
52 Turn Buckles  
52 Steps  
52 Gunnel Caps  
52 Rub Rails  
53 Bow Anchor Rollers  
53 Chain Stop  
53 Anchor Chains  
53 Anchor Swivels  
54 Ski Pylons  
55 Ski Tows  
55 Sampson Post  
56 Antenna Mounts  
56 Flat Screen TV Bracket  
57 Vent Grills  
57 Speaker Covers  
58 Custom Parts

## 59-72 ACCESS HARDWARE

60 Slam Latches  
61 Barrel Latches  
61 Transom Door Latch  
61 Cabinet Latches  
61 Deck Tie-Down  
61 Spring Hatch Opening  
62 Lifting Rings  
62 Hatch Pulls  
62 Door Stops  
63-66 Cast Hinges  
67-69 Stamped Hinges  
70 Hinges  
70 Piano Hinges  
70-71 Seat Hinges  
72 Custom hinges

## 73-76 LADDERS

74 Under Swim Platform Ladder  
75 Telescoping Deck Ladders  
76 Dive Ladder

## 77-82 STEERING WHEELS

78-79 Stainless Steel Steering Wheels  
80 Aluminum Steering Wheels  
80-82 Sport Steering Wheels  
82 Steering Wheel Hub  
82 Steering Wheel Cap Assembly

## 83-86 MRO

84 Cover-Alls  
85 Tape Measures  
85 Nylon Wire Ties  
85 Wire Tie Fasteners  
85 Loctite  
86 Coaxial Speakers  
86 Speaker Grills  
86 Hose Clamps  
87 Index

# Material Specifications

## BRASS AND BRONZE STANDARD CASTING ALLOYS

	SPECIFICATIONS						CHEMICAL COMPOSITIONS								MECHANICAL PROPERTIES						
	1978 CDA	1961 ASTM	1981 SAE	ALLOY ID	MILITARY	AMS	Cu %	Sn %	Pb %	Zn %	Ni %	Fe %	Al %	Others %	Tensile Strength		Yield Strength		Brinell Hardness	Weight Lbs./In. <sup>3</sup>	Machinability Free Cut/YB-100
															min.ksi	typ.ksi	min.ksi	typ.ksi			
Red Brass	C83300	—	—	131	—	—	93	1.5	1.5	4	—	—	—	—	—	32	—	10	35	.318	35
	C83600	B584-836	C83600	115	C-22229Gr2	—	85	5	5	5	—	—	—	—	30	37	14	17	50-65	.318	84
	C83800	B584-838	C83800	120	—	—	83	4	6	7	—	—	—	—	29	35	12	16	50-60	.312	90
Yellow Brass	C85400	B584-854	C86400	403	—	—	67	1	3	29	—	—	—	—	30	34	11	12	40-60	.305	80
	C85700	B564-857	—	405-2	C-15345Gr3	—	63	1	1	34.7	—	—	.3	—	40	50	14	18	75	.304	80
Manganese Bronze	C86200	B584-862	C86200	423	C-22229Gr9	—	64*	—	—	26	—	3	4	—	90	95	45	48	170†	.288	30
	C86300	B584-863	C86300	424	C-22229Gr8	4862B	63*	—	—	25	—	3	6	—	110	119	60	83	225†	.283	8
	C86500	B584-865	C86500	421	C-22229Gr7	4860A	58	5	—	40	—	1	1	Mn .25	65	71	25	28	130†	.301	26

\* Chemicals may be varied to yield chemical properties  
† Brinell 3,000kg load

## ALUMINUM STANDARD SAND AND PERM MOLD CASTING ALLOYS

AA #	SPECIFICATIONS						CHEM. COMP.				MECHANICAL PROPERTIES								
	Former Designation	S=Sand P=Perm Mold	Federal		Current Same as AA Old ASTM #'s		SAE	Cu %	Si %	Mg %	Zn %	Temper		Tensile Strength, psi		Yield Strength, psi		Brinell Hardness	
			QA601E (S)	QA596 (PM)	B-26 (S)	B-108 (PM)						S	PM	S	PM	S	PM	S	PM
319	319, Allcast	S,P	319	319	SC64D	SC64D	326	3.5	6.0			T62 T7 F	F T6 T551	41 39 27	34 40 36	32 26 18	19 27 28	85 60 75	85 95 105
356.0	356	S,P	356	356	SG70A	SG70A	323		7.0	0.3		T51 T6 T7	T61	25 33 34	41	20 24 30	30	60 70 75	90
713.0	613, Tenzaloy	S,P	Tenzaloy	Tenzaloy	ZG81A		315	0.7		0.4	7.5	ForT5	T5	34	40	23	27	75	80

NOTE: Unless otherwise specified, these alloys are not heat treated.

## STAINLESS STEEL

Element	CHEMICAL COMPOSITIONS								MECHANICAL PROPERTIES					
	C	Mn	Ph	S	Si	Cr	Ni	Fe	Tensile Strength, psi		Yield Strength, psi		Hardness	
303	0.15	2.00	0.200	0.150	1.00	17.00-19.00	8.00-10.00	Balance	95,000		45,000		Brinell 160	
304	0.08	2.00	0.045	0.030	1.00	18.00-20.00	8.00-12.00	Balance	90,000		40,000		Rockwell b85	
316	0.08	2.00	0.045	0.030	1.00	16.00-18.00	10.00-14.00	Balance	115,000		75,000		—	
17-4	0.04	0.28	—	—	0.60	16.00	4.25	Balance	150,000		110,000		Rockwell c34	

## BOAT SHAFTING

	CHEMICAL COMPOSITIONS													MECHANICAL PROPERTIES				
	Cr	Ni	Cu	Mo	N	C	Mn	Ph	S	Si	Cb	V	Fe	Tensile Strength, psi	Yield	Torsional Yield	Elong., % in 2"	Red. of Area, %
AQUANOX™ 17 .750" - 8.000" dia	15.00-17.00	3.00-5.00	3.00-5.00	—	0.20-0.30	0.07	1.00	0.04	0.03	1.00	0.15-0.45	—	Balance	135,000	105,000	70,000	16	50
AQUANOX™ 19 .750" - 1.50" dia	18.00-20.00	8.00-10.50	—	—	0.20-0.40	0.08	2.00	0.04	0.03	1.00	—	—	Balance	130,000	105,000	70,000	20	55
AQUANOX™ 19 1.50" - 2.00" dia	18.00-20.00	8.00-10.50	—	—	0.20-0.40	0.08	2.00	0.04	0.03	1.00	—	—	Balance	115,000	85,000	57,000	25	55
AQUANOX™ 19 2.00" - 2.50" dia	18.00-20.00	8.00-10.50	—	—	0.20-0.40	0.08	2.00	0.04	0.03	1.00	—	—	Balance	105,000	60,000	40,000	30	55
AQUANOX™ 19 2.50" - 3.00" dia	18.00-20.00	8.00-10.50	—	—	0.20-0.40	0.08	2.00	0.04	0.03	1.00	—	—	Balance	100,000	55,000	36,600	35	55
AQUANOX™ 19 3.00" - 12.00" dia	18.00-20.00	8.00-10.50	—	—	0.20-0.40	0.08	2.00	0.04	0.03	1.00	—	—	Balance	95,000	50,000	33,000	35	55
AQUANOX™ 22 .75" - 1.25" dia	20.50-23.50	11.50-13.50	—	1.50-3.00	0.20-0.40	0.06	4.00-6.00	0.04	0.03	1.00	0.10-0.30	0.10-0.30	Balance	145,000	130,000	86,600	18	45
AQUANOX™ 22 1.25" - 2.00" dia	20.50-23.50	11.50-13.50	—	1.50-3.00	0.20-0.40	0.06	4.00-6.00	0.04	0.03	1.00	0.10-0.30	0.10-0.30	Balance	135,000	105,000	70,000	20	50
AQUANOX™ 22 2.00" - 2.50" dia	20.50-23.50	11.50-13.50	—	1.50-3.00	0.20-0.40	0.06	4.00-6.00	0.04	0.03	1.00	0.10-0.30	0.10-0.30	Balance	120,000	95,000	63,300	20	50
AQUANOX™ 22 2.50" - 3.00" dia	20.50-23.50	11.50-13.50	—	1.50-3.00	0.20-0.40	0.06	4.00-6.00	0.04	0.03	1.00	0.10-0.30	0.10-0.30	Balance	115,000	75,000	50,000	25	50
AQUANOX™ 22 3.00" - 12.00" dia	20.50-23.50	11.50-13.50	—	1.50-3.00	0.20-0.40	0.06	4.00-6.00	0.04	0.03	1.00	0.10-0.30	0.10-0.30	Balance	100,000	55,000	36,600	30	50
AQUANOX™ 22HS 2.250" - 6.00" dia	20.50-23.50	11.50-13.50	—	1.50-3.00	0.20-0.40	0.06	4.00-6.00	0.04	0.03	1.00	0.10-0.30	0.10-0.30	Balance	130,000	105,000	70,000	15	45

# Plumbing

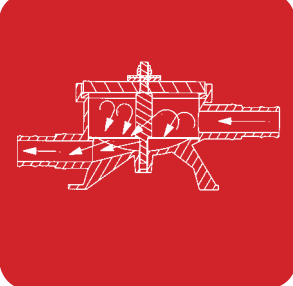
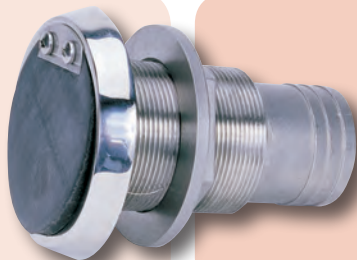
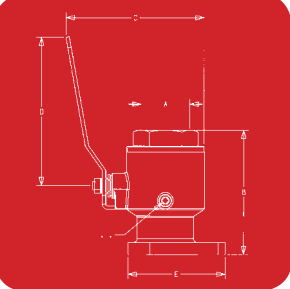
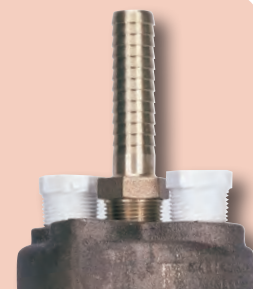
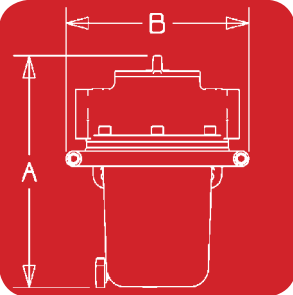
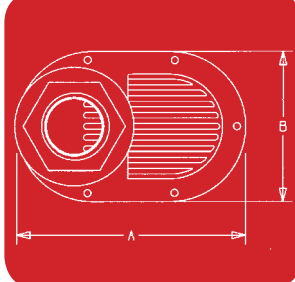
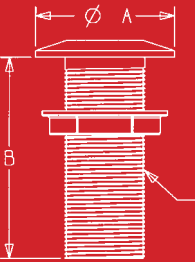
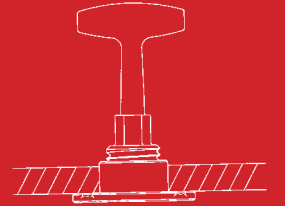
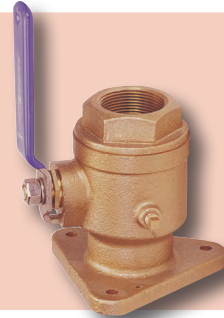
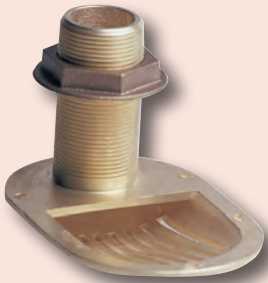
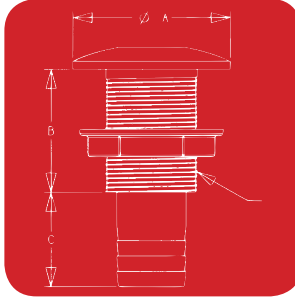
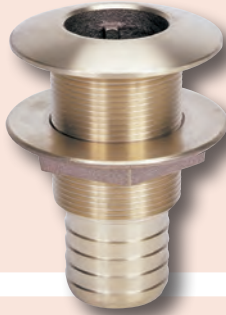
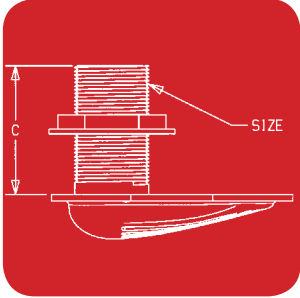
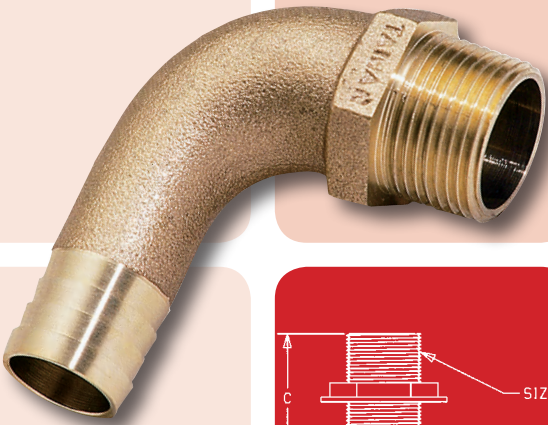

# Valves

## BALL VALVES - Cathodic Protection Required

Cast bronze body, stainless steel handle. Cathodic protection required.

Part No.	Pipe Size	Length	Handle	Drain	Ground Screw	Full Port
	(A)	(B)	(C)			
BVLV0.250-FPHL	1/4"	1-7/8"	3-3/16"	N	N	Y
BVLV0.375-FPHL	3/8"	1-7/8"	3-3/16"	N	N	Y
BVLV0.500-FPHL	1/2"	1-7/8"	3-3/16"	N	Y	Y
BVLV0.750-FPHL	3/4"	2-1/2"	4-3/4"	Y	Y	Y
BVLV1.000-FPHL	1"	2-3/4"	4-3/4"	Y	Y	Y
BVLV1.250-FPHL	1-1/4"	3"	5-3/16"	Y	Y	Y
BVLV1.500-FPHL	1-1/2"	3-5/8"	5-3/8"	Y	Y	Y
BVLV2.000-FPHL	2"	4-1/8"	6-3/8"	Y	Y	Y
BVLV2.500-B-HL	2-1/2"	5"	8-3/8"	Y	Y	N
BVLV3.000-B-HL	3"	5-3/4"	11-3/8"	Y	Y	N
BVLV4.000-B-HL	4"	7"	11-3/8"	Y	Y </td <td>N</td>	N

Drain plugs are provided for winterization. Failure to properly winterize can cause damage that is not covered under warranty.

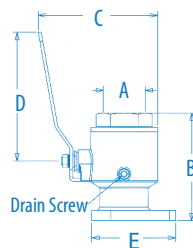
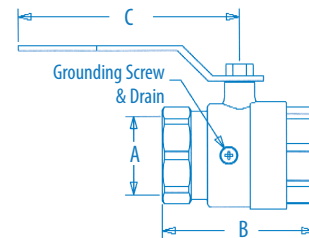

## TRI-ANGLE SEACOCKS

Same precision specifications as our ball valves. Triangular flange machined smooth for flush-fit hull mounting. Includes ground screw, mounting boss and drain. Cathodic protection required.

Part No.	Pipe Size	Length	Height	Handle	Base
	(A)	(B)	(C)	(D)	(E)
SEAC0.750-B	3/4"	3-9/16"	3-1/16"	4-13/16"	3-1/2"
SEAC1.000-B	1"	4-1/4"	4"	5-1/2"	3-5/8"
SEAC1.250-B	1-1/4"	4-7/8"	4-11/4"	5-1/2"	4"
SEAC1.500-B	1-1/2"	5-5/16"	4-3/4"	5-1/2"	4-1/2"
SEAC2.000-B	2"	5-5/8"	5-1/2"	5-1/2"	5-1/8"
SEAC2.500-B	2-1/2"	6-7/8"	6-1/2"	8"	5-1/2"

Drain plugs are provided for winterization. Failure to properly winterize can cause damage that is not covered under warranty.

# Thru-Hulls

Our thru-hulls and water pickups are cast of red bronze, also known as naval bronze, the most corrosion resistant copper alloy available. Our standard mushroom thru-hulls are also available in 316 stainless steel, for those who prefer the excellent characteristics of this metal. Our parts are cast with a very sturdy wall thickness and machined with straight pipe thread, which blends into tapered pipe thread at the end of the neck. This thread configuration mates with virtually any piping or valve

without the need for adapter connections. Generous neck lengths, threaded close to the flange, fit any hull thickness. Machined sealant groove on back of flange face to prevent leakage. Complete with flanged jam nut. *Note-* It's required to have cathodic bonding system to insure proper service of all our plumbing components.

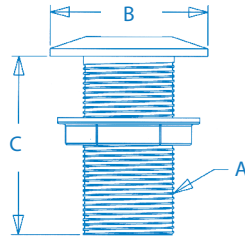

## STANDARD MUSHROOM

Machine Finish Bronze	Chrome Plated Bronze	316 Stainless Steel	Size (NPSM)	Flange O.D.	Neck Length
Part No.	Part No.	Part No.	(A)	(B)	(C)
THMR.500-B	THMR.500-C	N/A	1/2"	1-3/4"	2-1/4"
THMR.750-B	THMR.750-C	N/A	3/4"	1-3/4"	2-1/4"
THMR1.000-B	THMR1.000-C	THMR1.000-S	1"	2-1/4"	2-1/2"
THMR1.250-B	THMR1.250-C	N/A	1-1/4"	3"	3-1/4"
THMR1.500-B	THMR1.500-C	THMR1.500-S	1-1/2"	3-1/4"	3-1/2"
THMR2.000-B	THMR2.000-C	THMR2.000-S	2"	3-1/2"	3-1/2"

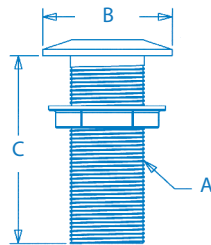
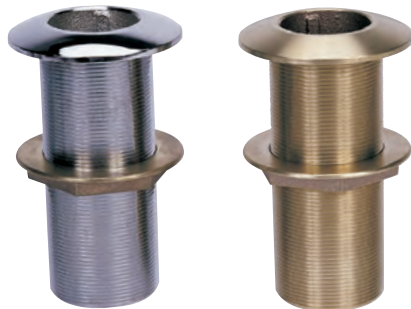

## EXTENDED MUSHROOM

Machine Finish Bronze	Chrome Plated Bronze	Size (NPSM)	Flange O.D.	Neck Length
Part No.	Part No.	(A)	(B)	(C)
THME0.500-B	THME0.500-C	1/2"	1-3/4"	4"
THME0.750-B	THME0.750-C	3/4"	1-3/4"	4"
THME1.000-B	THME1.000-C	1"	2-1/4"	4-1/4"
THME1.250-B	THME1.250-C	1-1/4"	2-1/4"	4-1/4"
THME1.500-B	THME1.500-C	1-1/2"	3"	5"
THME2.000-B	THME2.000-C	2"	3-1/2"	5-1/2"

## SHORT MUSHROOM

Machine Finish Bronze	Chrome Plated Bronze	Size (NPSM)	Flange O.D.	Neck Length
Part No.	Part No.	(A)	(B)	(C)
THMR1.250-B-SH	THMR1.250-C-SH	1-1/4"	2-7/8"	2"
THMR1.500-B-SH	THMR1.500-C-SH	1-1/2"	3-1/4"	2"
THMR2.000-B-SH	THMR2.000-C-SH	2"	3-5/8"	2"

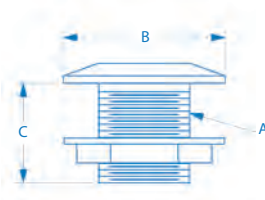

# Thru-Hulls

## BARBED MUSHROOM

Marine Hardware,™ Inc.'s barbed thru-hull fittings are designed for use above the waterline, attached directly to hose. The bodies have straight thread below the barbed section. All have heavy wall construction for strength and wrench flats on the end of the threaded portion for easy, one-person installation.

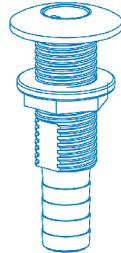
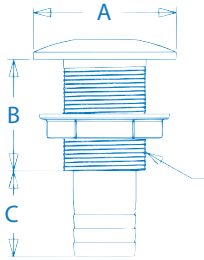

316 SS Common Head	Machine Finish Bronze	Chrome Plated Bronze	Size	Fits Hose Dia.	Flange Size	Neck Length	Barb Length
Part No.	Part No.	Part No.	(NPSM)		(A)	(B)	(C)
THMB0.500-S	THMB0.500-B	THMB0.500-C	1/2"	1/2"	1-1/2"	1-1/2"	1-1/4"
THMB0.750-S	THMB0.750-B	THMB0.750-C	3/4"	3/4"	1-3/4"	2"	1-1/2"
THMB0.75SHORT-S	N/A	N/A	3/4"	3/4"	1-3/4"	1"	1-1/4"
THMB1.000-S	THMB1.000-B	THMB1.000-C	1"	1"	2-1/4"	2-1/4"	1-1/4"
THMB1.125-S	THMB1.00X1.125-B	THMB1.00X1.125-C	1"	1-1/8"	2-1/4"	2-1/4"	1-1/2"
THMB1.250-S	THMB1.250-B	THMB1.250-C	1-1/4"	1-1/4"	2-3/4"	2-1/4"	1-1/2"
THMB1.500-S	THMB1.500-B	THMB1.500-C	1-1/2"	1-1/2"	3"	2-1/2"	1-1/2"
THMB1.500-S-FLAP	THMBE-1.5-B-FLAP	THMBE-1.5-C-FLAP	1-1/2"	1-1/2"	3"	3-3/4"	1-7/16"
THMB2.000-S	THMB2.000-B	THMB2.000-C	2"	2"	3-1/2"	2-1/2"	1-3/4"
THMB2.000-S-FLAP	N/A	THMB2.000-C-FLAP	2"	2"	3-1/2"	2-1/2"	1-3/4"

## COMMON HEAD THRU-HULL FITTING

These Thru-hull fittings have the same quality construction and finish as our standard barbed mushroom fittings. Six sizes available for 5/8" to 2" hose. Flanges share only three head sizes for uniformity of style when multiple hose sizes are used.



316 SS Common Head	Thread (NPSM)	Fits Hose Dia.	Flange Size	Neck Length	Barb Length
Part No.			(A)	(B)	(C)
THMB0.500-X	1/2"	5/8"	1-7/8"	1-5/8"	1"
THMB0.750-X	3/4"	3/4"	1-7/8"	1-5/8"	1-1/8"
THMB1.000-X	1"	1"	1-7/8"	1-5/8"	1-3/16"
THMB1.125-X	1"	1-1/8"	2-3/8"	1-7/8"	1-1/4"
THMB1.250-X	1-1/4"	1-1/4"	2-3/8"	1-7/8"	1-5/8"
THMB1.500-X	1-1/2"	1-1/2"	2-3/8"	1-7/8"	1-1/2"
THMB2.000-X	2"	2"	3-1/4"	3"	2"

Dimensions of these units are identical to our stainless clad units for easy interchangeability on any vessel.

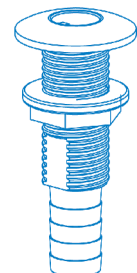
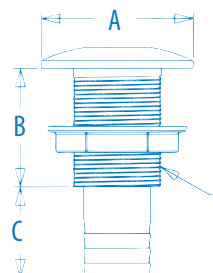

# Thru-Hulls

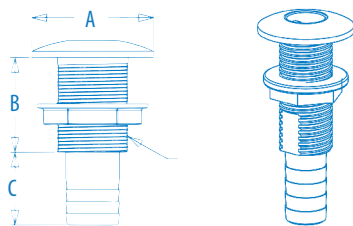

## STAINLESS CLAD THRU-HULL FITTING

A tough glass filled nylon body is molded around an attractive stainless flange. Get the look and feel of stainless thru hulls at a fraction of the price. Nylon body is grey in color to match stainless flange. Flange sizes are uniform for multi-outlet applications.

SS Clad Nylon Common Head	Thread (NPSM)	Fits Hose Dia.	Flange Size (A)	Neck Length (B)	Barb Length (C)
Part No.					
THMB0.500-N	1/2"	5/8"	1-7/8"	1-5/8"	1"
THMB0.750-N	3/4"	3/4"	1-7/8"	1-5/8"	1-1/8"
THMB1.000-N	1"	1"	1-7/8"	1-5/8"	1-3/16"
THMB1.125-N	1"	1-1/8"	2-3/8"	1-7/8"	1-1/4"
THMB-1.250-N	1-1/4"	1-1/4"	2-3/8"	1-7/8"	1-5/8"
THMB-1.500-N	1-1/2"	1-1/2"	2-3/8"	1-7/8"	1-1/2"
THMB-2.000-N	2"	2"	3-1/4"	2-1/4"	2"

Dimensions of these units are identical to our common head units for easy interchangeability on any vessel.

## LOW VOLUME WATER PICKUP

A thru-hull style of water pickup for low volume pumps such as bait well pumps. Designed like our thru-hulls, with straight pipe threads on the neck and tapered pipe threads at the end to mate with other fittings. Installs with the included flanged jam nut, like a regular thru-hull, with two #8 flat head screws in the flange to hold the cut-out "scoop" in the correct orientation. Available in machine-finish bronze only. Optional milled slots available for custom applications such as generator cooling.

Part No.	Size (NSPM)	Flange O.D.	Neck Length
	(A)	(B)	(C)
THMR0.750-B-HSWP	3/4"	1-7/8"	2-1/4"
THMR1.000-B-HSWP	1"	2-1/4"	2-1/2"
THMR1.25B-HSWP	1-1/4"	2-3/4"	3-1/4"
THMR1.50B-HSWP	1-1/2"	3"	3-1/2"
THMR0.750B-HSWP-FT	3/4"	1-7/8"	2-1/4"

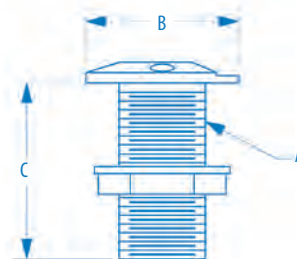

## THRU-HULL INSTALLATION TOOLS

Three stage tools come in both small and large, to fit all Marine Hardware,™ Inc.'s Thru-Hull installations.

Part No.	Description
THIT1.50-LG-A	For use with nominal 1-1/4" – 2" Thru-Hulls
THIT1.00-SM-A	For use with nominal 1/2" – 1" Thru-Hulls

## STAINLESS STEEL/PLASTIC THRU-HULL-90°

This thru-hull has all the appearance of a stainless steel thru-hull with a composite plastic attachment and hose barb. Compact design is great for limited space. Designed to receive 3/4" hose.

Part No.	Neck Length	Flange O.D.
THMB90-0.75-S	3/4"	1-3/4"

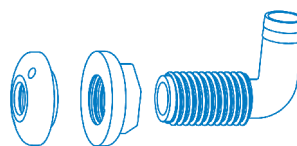

# Thru-Hulls



## HIGH SPEED WATER PICKUPS

Cast from bronze with extra-sturdy wall thickness. Our pickups have a generous neck length to fit any hull and have straight pipe thread blending into tapered pipe thread at end for easy connection to piping or valves. Complete with flanged jam nut. The 1" size is our exclusive design for competition-style ski boats. It is available in bronze or 316 stainless steel.

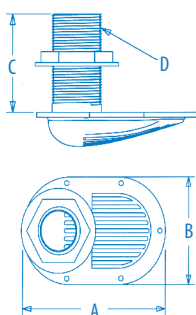

Part No.	Material	Size (NPSM)	Scoop Length	Scoop Width	Neck Length
		(D)	(A)	(B)	(C)
HSWP0.500-B	Bronze	1/2"	3-5/16"	2-1/16"	2-1/4"
HSWP0.750-B	Bronze	3/4"	4"	3"	2-1/2"
HSWP1.000-B	Bronze	1"	4"	2-1/2"	2-1/2"
HSWP1.000-S	SS	1"	4"	2-1/2"	2-1/2"
HSWP1.250-B	Bronze	1-1/4"	6-1/2"	4"	3-3/8"
HSWP1.500-B	Bronze	1-1/2"	6-1/2"	4"	3-3/8"
HSWP2.000-B	Bronze	2"	8"	5-1/2"	3-3/8"

## PICKUP SCREENS-Cast Brass

These round, cast brass screens are designed as filters to fit all Marine Hardware,™ Inc. thru-hulls below the water line. Easy to install with surface mount fasteners.

Part No.	Fits Thru-Hull Flange Dia.	Height
THSCRN0.75-B	1-7/8"	5/8"
THSCRN1.00-B	2-1/4"	5/8"
THSCRN1.25-B	2-7/8"	11/16"
THSCRN1.50-B	3-1/4"	3/4"



## PIPE NIPPLES W/OUT HEX

Marine Hardware,™ Inc. is the only source for pipe nipples in bronze. This alloy is resistant to work hardening and is less likely to become brittle or crack when subjected to vibration. The corrosion resistance and alloy compatibility of Marine Hardware,™ Inc.'s pipe nipples make them ideally suited for use with other bronze fittings such as ball valves, sea strainers and seacocks.

Part No.	Description
PTPNM-0.50-NOHEX	Bronze 1/2" NPT Pipe Nipple, No Hex
PTPNM-0.75-NOHEX	Bronze 3/4" NPT Pipe Nipple, No Hex
PTPNM-1.00-NOHEX	Bronze 1" NPT Pipe Nipple, No Hex
PTPNM-1.25-NOHEX	Bronze 1-1/4" NPT Pipe Nipple, No Hex
PTPNM-1.50-NOHEX	Bronze 1-1/2" NPT Pipe Nipple, No Hex
PTPNM-2.00-NOHEX	Bronze 2" NPT Pipe Nipple, No Hex



## PIPE NIPPLES WITH HEX

Part No.	Description
PTPNM-CX0.50	Bronze 1/2" NPT Pipe Nipple w/Hex
PTPNM-CX0.75	Bronze 3/4" NPT Pipe Nipple w/Hex
PTPNM-CX1.00	Bronze 1" NPT Pipe Nipple w/Hex
PTPNM-CX1.25	Bronze 1-1/4" NPT Pipe Nipple w/Hex
PTPNM-CX1.50	Bronze 1-1/2" NPT Pipe Nipple w/Hex
PTPNM-CX2.00	Bronze 2" NPT Pipe Nipple w/Hex



# Thru-Hulls

## MULTI PORT THRU-HULL

An innovative solution to the problem of outputting several water lines without cluttering the esthetic styling of the boat with numerous thru-hulls. Our unit is tapped for five 3/4" tapered pipe thread water fittings, and is engineered with the capacity to work with all outflows operating simultaneously. This one product eliminates the need for four extra thru-hulls, and is supplied with the 90 degree elbow that ensures positive looping. Manifold is cast red bronze, thru-hull is polished chrome-plated red bronze, elbow is heavy-duty PVC.

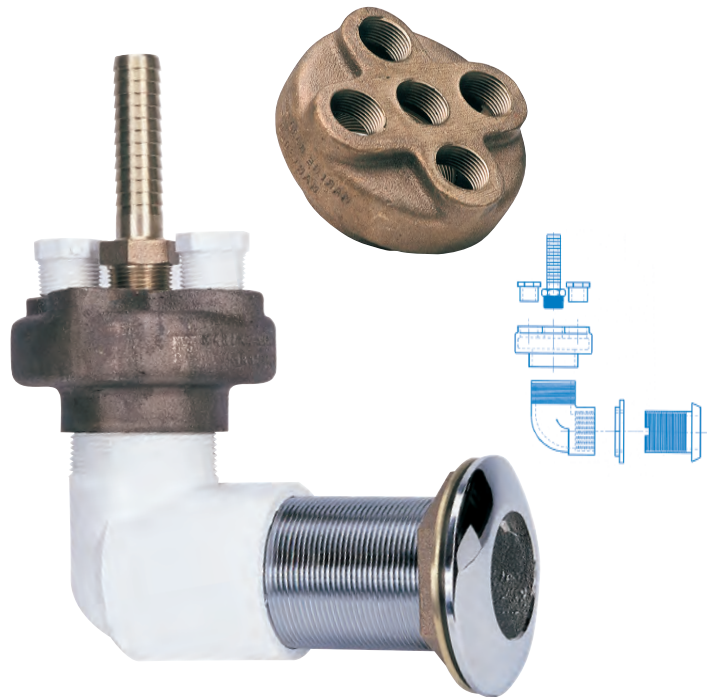

Part No.	Description
MPTH5 X 0.75NPT-B	Complete Assembly
MPMF5 X 0.75NPT-B	Bronze Manifold Only
0379MPH-ELBOW	2" Elbow 90°, PVC Str. L, Sch. 80
PTHA-X-E-0.75X0.75	3/4" NPT x 3/4" Barb, Ext Lth, Strt ftg., Brz
0379MPH-PLUG	3/4" NPT Plug, Hex Hd, PVC Sch. 80
03770.750BRS-SQ	3/4" NPT Plug, Sq Hd, Solid Brass

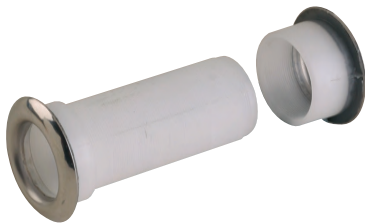

## STAINLESS CLAD DRAIN TUBE

Plastic body can be cut to length leaving only stainless clad flanges visible. Matches style of stainless and chrome thru-hulls that have become increasingly popular.

Part No.	Size	Length
SSAD50001	3/4"	2"



## DRAIN FLANGE W/BARBS

Cast stainless steel.

Part No.	Size	Length
SSAD50002	1/2"	3/4"

# Faucet

## FAUCET - Washdown

Marine Hardware,™ Inc.'s wash down faucet is stylish and compact. It fits under the gunnels of most sport fishing boats for fresh or salt water wash down. Cruisers will add one to the anchor locker to hose mud and debris off of the ground tackle before stowing. Outlet side fits standard garden hose fittings, inlet side is 1/2" NPT. Construction is cast stainless steel with mirror polish finish. From full-on to full-off position requires only a quarter turn. Requires three, #10 flat head screws.



Part No.	Pipe Thread
SSWF62100	1/2"-N.P.T.

# Sea Strainers

## UNIVERSAL SWIVEL MOUNT

Marine Hardware,™ Inc.'s Universal Mount Sea Strainers incorporate all the best features. Starting with a cast bronze housing, all units include a pull out strainer screen assembly for easy spill-proof maintenance. The inspection lens is heavy walled for maximum strength and is securely fastened to the housing with a bronze retainer ring plate. Our unique design insures a firm mount to the engine stringers and allows full 360° rotation of the top housing to optimize plumbing fittings. A perfect choice for port and starboard engine installations.

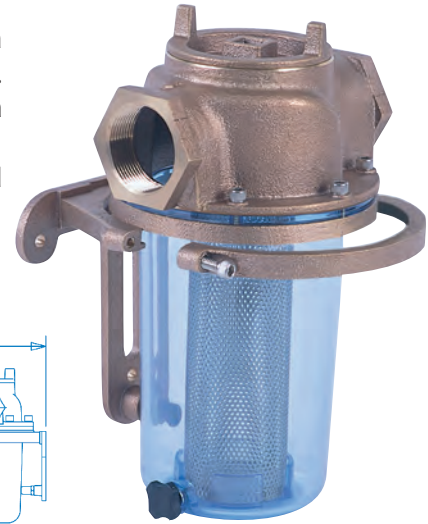

Part No.	Inlet/Outlet	A	B	C
SEASUM 0.750	3/4" NPT	7.52"	5.92"	5.56"
SEASUM 1.000	1" NPT	7.52"	5.92"	5.56"
SEASUM 1.250	1-1/4" NPT	10.58"	6.75"	6.40"
SEASUM 1.500	1-1/2" NPT	10.58"	6.75"	6.40"
SEASUM 2.000-SM	2" NPT	13.68"	8.25"	8.50"
SEASUM 2.500	2-1/2" NPT	14.00"	10.82"	9.85"

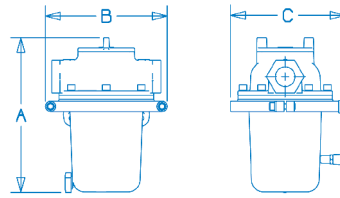

Drain plugs are provided for winterization. Failure to properly winterize can cause damage that is not covered under warranty.

Size	Replacement Part No.				
	Screen	Bowl	Cap	O-ring & Maint. Kit	Drain Plug
3/4"	SEASSCREEN-0.750	SEASBOWL-.75/1.0	SEASCAP-0.75/1.00	SEASKIT-0.75/1.0	SEASDRAIN-PLUG
1"	SEASSCREEN-0.750	SEASBOWL-.75/1.0	SEASCAP-0.75/1.00	SEASKIT-0.75/1.0	SEASDRAIN-PLUG
1-1/4"	SEASSCREEN-1.500	SEASBOWL-125/150	SEASCAP-1.25	SEASKIT-1.25/1.5	SEASDRAIN-PLUG
1-1/2"	SEASSCREEN-1.500	SEASBOWL-125/150	SEASCAP-1.50	SEASKIT-1.25/1.5	SEASDRAIN-PLUG
2"	SEASSCREEN-2.000	SEASBOWL-200/250	SEASCAP-2.00-SM	SEASKIT-2.0/2.5	SEASDRAIN-PLUG
2-1/2"	SEASSCREEN-2.000	SEASBOWL-200/250	SEASCAP-2.00-SM	SEASKIT-2.0/2.5	SEASDRAIN-PLUG

## TOP VIEW MULTI-PORT SEA STRAINER - Self-Cleaning

This compact assembly has proven efficient and reliable for years in the field in many types of craft, from ski boats to sport fisher to cruisers. Cast in bronze, the multi-port strainers are precision machined, and assembled with the finest hardware available. The clear heavy duty lens allows easy inspection and a hand knob facilitates clean out with no need for tools. A plug simplifies drainage for winterization. These units come standard with barbs for 1-1/4" diameter inlet hose, but can be tapped to accept 1" pipe fittings and elbows, if required for your specific installation. The outlet side is tapped for two 3/4" NPT and one 1" NPT.

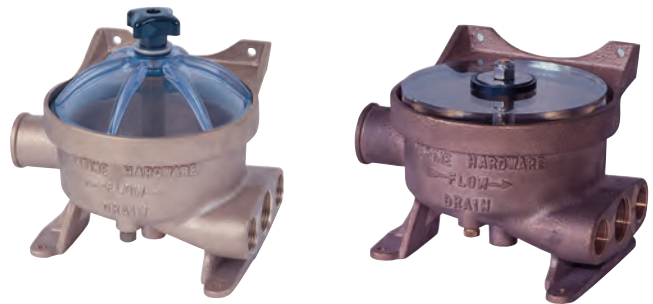

Part No.	Lens	Inlet	Outlet (s)
SEASMP-NPT-DOME	Dome	1-1/4" dia. hose	(2) 3/4" NPT & 1" NPT
SEASMP-NPT	Flat	1-1/4" dia. hose	(2) 3/4" NPT & 1" NPT

Drain plugs are provided for winterization. Failure to properly winterize can cause damage that is not covered under warranty.

## REPLACEMENT PARTS

Part No.	Description
SEASSCREEN	Replacement Screen
SEASLENS-DOME	Acrylic Dome Lens for Multi-Port Sea Strainer
SEASLENS	Acrylic Flat Lens
SEAS3GASKETS	3-Piece Gasket Set for SEASMP-NPT

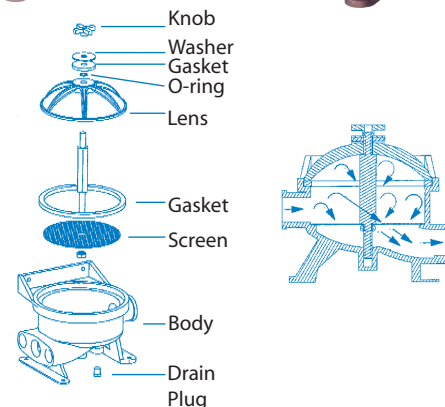

# Pipe-to-Hose Fittings

Constructed of bronze, these fittings are CNC machined to class 3 fits, ensuring leak-free joints. All units are precision turned on hose end to ensure snug hose fits. All parts are bulk-packed.

## STRAIGHT PIPE-TO-HOSE ADAPTERS

Cast red brass, tapered pipe threads.

Part No.	Pipe Size (NPT)	Hose Barb O.D.	Hex Size
PTHAS-0.75X0.75	3/4" NPT	3/4"	1-1/4"
PTHAS-E-0.75X0.75 *	3/4" NPT	3/4"	1-1/4"
PTHAS-0.75X1.00	3/4" NPT	1"	1-3/8"
PTHAS-0.75X1.12	3/4" NPT	1-1/8"	1-1/4"
PTHAS-1.00X1.00	1" NPT	1"	1-1/2"
PTHAS-1.00X1.25	1" NPT	1-1/4"	1-1/2"
PTHAS-1.25X1.25	1-1/4" NPT	1-1/4"	2"
PTHAS-2.00X2.00	2" NPT	2"	2-5/8"
PTHAS-4.00X3.00	4" NPT	3"	4-1/2"

\* Extended Barb



## MALE 90° PIPE-TO-HOSE ADAPTERS

Cast red brass, tapered pipe threads.

Part No.	Angle	Pipe Size	Hose Size
PTHA90-0.75X0.75	90°	3/4" NPT	3/4"
PTHA90-1.00X1.00	90°	1" NPT	1"
PTHA90-1.25X1.0F	90°	1" NPT	1-1/4"
PTHA90-1.25X1.25	90°	1-1/4" NPT	1-1/4"
PTHA90-1.50X1.50	90°	1-1/2" NPT	1-1/2"
PTHA90-2.00X2.00	90°	2" NPT	2"
PTHA90-2.50X2.50	90°	2-1/2" NPT	2-1/2"
PTHA90-3.00X3.00	90°	3" NPT	3"
PTHA90-4.00X4.00	90°	4" NPT	4"

## FEMALE 90° PIPE-TO-HOSE ADAPTERS

Cast red brass, tapered pipe threads.

Part No.	Angle	Pipe Size	Hose Size
PTHAF-0.50	90°	1/2" NPT	1/2"
PTHAF-0.75	90°	3/4" NPT	3/4"
PTHAF-1.00	90°	1" NPT	1"
PTHAF-1.00x1.25	90°	1" NPT	1-1/4"
PTHAF-1.25	90°	1-1/4" NPT	1-1/4"
PTHAF-1.50	90°	1-1/2" NPT	1-1/2"
PTHAF-2.00	90°	2" NPT	2"



# Fuel Line Fittings

Fuel line fittings are uniquely designed for marine applications. Extra long hose barbs to accommodate two hose clamps. Machined from 360 brass. NPT (National Pipe Thread) for secure –leak proof installations.

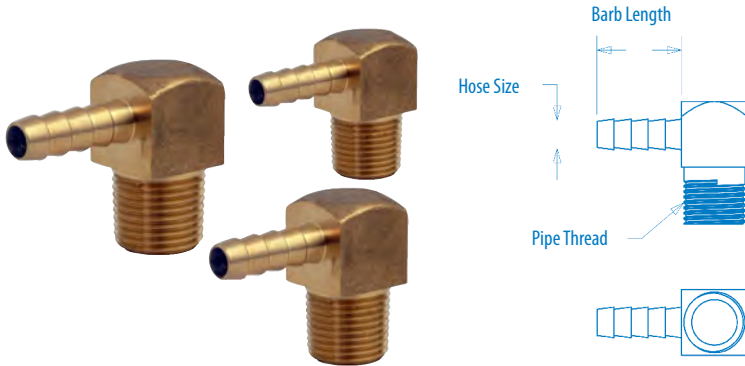

## 90° FUEL FITTINGS

Part No.	Pipe Thread	Hose Dia.	Barb Length
PTHA90-0.25X0.38	1/4"	3/8"	1.115
PTHA90-0.25X0.50	1/4"	1/2"	1.115
PTHA90-0.38X0.25	3/8"	1/4"	1.115
PTHA90-0.38X0.31	3/8"	5/16"	1.115
PTHA90-0.50X0.38	1/2"	3/8"	1.115
PTHA90-0.50X0.50	1/2"	1/2"	1.115

## STRAIGHT FUEL FITTINGS

Part No.	Pipe Thread	Hose Dia.	Barb Length
PTHAS-0.125X0.19	1/8"	3/16"	.800
PTHAS-0.25 X 0.31	1/4"	5/16"	1.115
PTHAS-0.25X0.37	1/4"	3/8"	1.115
PTHAS-0.25 X 0.50	1/4"	1/2"	1.115
PTHAS-0.50 X 0.50	1/2"	1/2"	1.115
PTHAS-0.75X0.50	1/2"	3/4"	1.115

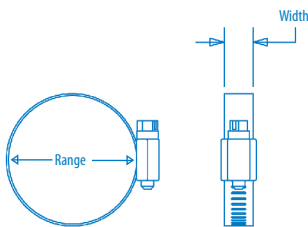
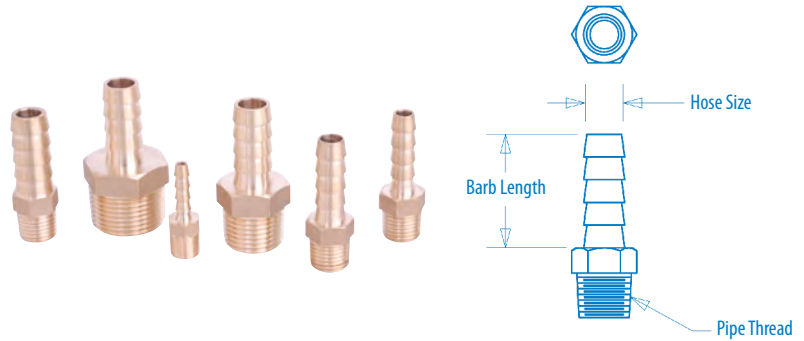

## HOSE CLAMPS

All clamps have stainless steel band and components.

Part No.	SAE	Width	Range
HSCP6D0616	MINI #4	5/16"	1/4"–5/8"
HSCP6D0822	MINI #6	5/16"	5/16"–7/8"
HSCP5D1022	#06	1/2"	3/8"–7/8"
HSCP5D1125	#08	1/2"	7/16"–1"
HSCP5D1427	#10	1/2"	1/2"–1-1/16"
HSCP5D1332	#12	1/2"	1/2"–1-1/4"
HSCP5D1832	N/A	1/2"	11/16"–1-1/4"
HSCP5D1838	#16	1/2"	11/16"–1-1/2"
HSCP5D1870	N/A	1/2"	11/16"–2-3/4"
HSCP5D2144	#20	1/2"	3/4"–1-3/4"
HSCP5D2751	#24	1/2"	1"–2"
HSCP5D3357	#28	1/2"	1-1/4"–2-1/4"

Part No.	SAE	Width	Range
HSCP5D4063	#32	1/2"	1-1/2"–2-1/2"
HSCP5D4670	#36	1/2"	1-3/4"–2-3/4"
HSCP5D5276	#40	1/2"	2"–3"
HSCP5D5782	#44	1/2"	2-1/4"–3-1/4"
HSCP5D6489	#48	1/2"	2-1/2"–3-1/2"
HSCP5D7095	#52	1/2"	2-3/4"–3-3/4"
HSCP5D76101	#56	1/2"	3"–4"
HSCP5D84108	#60	1/2"	3-1/4"–4-1/4"
HSCP5D64114	#64	1/2"	2-1/2"–4-1/2"
HSCP5D76127	#72	1/2"	3"–5"
HSCP5D92140	#80	1/2"	3-1/2"–5-1/2"
HSCP5D108152	#88	1/2"	4"–6"

# Fuel Vents

## FLUSH FUEL VENTS-90°

Our units feature wider flanges on the cup, to make it easier to fit and cover the edges of the hole drilled in the boat. Made of 316 stainless steel. Screened vent holes for safety. Complete assembly with all gaskets, washers and jam nut.

Part No.	Hose
SSGV66075	3/4"
SSGV66076	5/8"
SSGV66000	1"
SSGV66005	5/8"



## FLUSH FUEL VENT-Straight

Our units feature wider flanges on the cup, to make it easier to fit and cover the edges of the hole drilled in the boat. Made of 316 stainless steel. Screened vent holes for safety. Complete assembly with all gaskets, washers and jam nut.

Part No.	Hose
SSGV-66006	5/8"



## FLUSH FUEL VENT - 90° W/ Tank Pressure Adapter

Unique fuel tank vent incorporates a removable cover plate allowing installers to pressure test the entire system after installation with a common allen wrench.

Part No.	Hose
SSGV-66001	5/8"

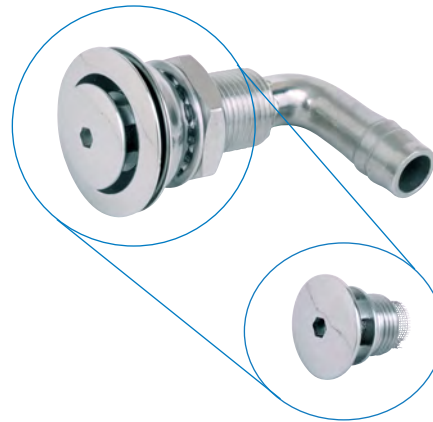

## CLAM VENT-Straight

Cast stainless steel straight tank vent for tight fit between hull and gunnel.

Part No.	Hose Size
SSGV-66004	5/8"



## CLAM VENT-90°

Cast stainless steel tank vent with elbow for tight fit between hull and gunnel.

Part No.	Hose Size
SSGV-66003	5/8"



## ROUND HEAD FUEL VENT-90°

Cast stainless steel straight tank vent for tight fit between hull and gunnel.

Part No.	Hose Size
SSGV-66077	5/8"



# Exhaust Systems

Marine Hardware,™ Inc.'s exhaust ports are the finest on the market today. Manufactured of stainless steel or nylon for ultimate corrosion resistance and strength, with a 60 durometer nitrile rubber flap to prevent backwash. Fasteners are high-grade stainless steel.

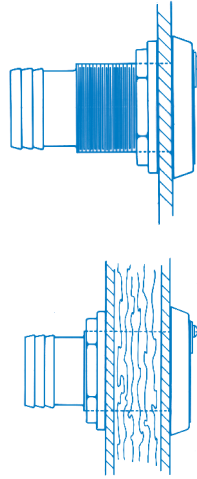

## 316 SS GENERATOR EXHAUST PORTS

Investment cast 316 stainless steel, full thread length to insure fit in any wall thickness. The design allows easy installation in boat hulls of varying thicknesses, from 3/8" to 2-1/4" as used in inboard/outboard transoms or sides of hull. Fully serviceable from outside the vessel. Complete with flapper.

Part No.	Hose Dia.
GETH1.500-S	1-1/2"
GETH1.625-S	1-5/8"
GETH2.000-S	2"
GETH2.500-S	2-1/2"
GETH3.000-S	3"
GETH3.500-S	3-1/2"



## CUT PIPE EXHAUST OUTLETS

The "bad boy" of our outlet offerings, the cut pipe is the finishing touch on the transom of your tournament ski boat or go fast. Fabricated 304 stainless steel and mirror polished.

Part No.	Hose Dia.	Flange Size	Muffler	Flange
SSEP3.500-45	3-1/2"	5-1/2"	No	Straight
SSEP3.500-30	3-1/2"	6"x6-5/8" Oval	Yes	Angle

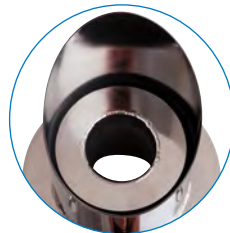

All units are available in straight thru bore and incorporates an internal muffer as shown.



## TURN DOWN EXHAUST OUTLETS

The cut pipe is the finishing touch on the transom of your tournament ski boat or go fast. Fabricated from 304 stainless steel and mirror polished.

Part No.	Hose Dia.	Flange Dia.	Muffler
SSEP3.000-TD	3"	4-1/2"	No
SSEP3.500-TD	3-1/2"	6"	Yes

# Exhaust Systems

## NYLON EXHAUST OUTLET

Molded in tough fiber filled nylon, this exhaust outlet offers an economical alternative to our cast outlet.

Part No.	Hose Dia.
GFEP3.500-BLK	3-1/2"



## EXHAUST ELBOWS & TEES

All are cast from red bronze and are shell cored to maintain wall thickness for easy hose fits and accomodates most sizes for gas or diesel cruisers. We can create custom angles and configurations to fit your special needs. Extra long necks to allow for two hose clamps.

Part No.	Type	Hose Dia.
EXEL-90-4X4-B	90° Elbow	4"
EXEL-90-5X5-B	45° Elbow	5"
EXEL-90-6X6-B	T-Fitting	6"
EXCEL-45-4X4-B	90° Elbow	4"
EXCEL-45-5X5-B	45° Elbow	5"
EXCEL-45-6X6-B	T-Fitting	6"
EXTE-4X4X4-B	90° Elbow	4"
EXTE-5X5X5-B	45° Elbow	5"
EXTE-6X6X6-B	T-Fitting	6"



## Battery Box

### BATTERY BOX

Injected molded plastic for maximum corrosion resistance. Complete with studs and fasteners. Fits all Group 27 batteries.

Part No.	Size
BBOX10001	14-13/16" x 5-15/16"



# Garboard Drains

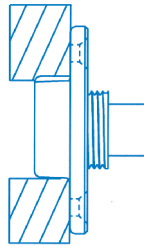

## PLUG STYLE GARBOARD DRAINS

Our plug style garboard drain assembly is cast brass threaded for 1/2" pipe plug. Flanges are drilled and countersunk for three #8 flat head mounting screws. We supply a plug with the dry seal thread pitch to ensure no water seepage. Unlike hollow plugs which are subject to cracking by the expansion of freezing water, our solid plug will withstand this pressure and remain watertight. Our plugs are chemically resistant to all fuels, oils and battery acids found in typical boat bilges. Bulk-packaged in 100 per box.

Part No.	Type	Size	Flange O.D.	Material	
				Flange	Plug
GARBO.500-P	Assembly	1/2"	2"	Brass	Brass
GARBO.500-PL	Assembly	1/2"	2-1/4"	Brass	Brass
PLUG0.500-P	Plug only	1/2"	N/A	N/A	Brass
PLUG0.500-PIN	Plug Only	1/2"	N/A	N/A	Brass
FLNG0.500-P	Flange only	1/2"	2"	Brass	N/A
FLNG0.500-PL	Flange only	1/2"	2-1/4"	Brass	N/A

## CROSS-PIN PLUG

All garboard drains available with cross-pin caps

Part No.	Type	Size	Flange O.D.	Material	
				Flange	Plug
PLUG0.500-PIN	Plug only	1/2"	N/A	N/A	Brass



## PLUG STYLE GARBOARD DRAINS-with O Ring

Part No.	Type	Size	Flange O.D.	Material	
				Flange	Plug
GARBO.500PB-OR	Assembly	1/2"	2"	Brass	Brass
GARBO.500PS-OR	Assembly	1/2"	2"	SS	SS

O-ring style sold as assembly only.

## CAPTIVE PLUG GARBOARD DRAIN

The plug is attached to the body by a stainless steel rod, preventing its loss and allowing full drainage when open.

Part No.	Type	Size	Flange O.D.	Material	
				Flange	Plug
GARBO.500PB-OR-RT	Ass'y	1/2"	2-1/4"	Brass	Brass

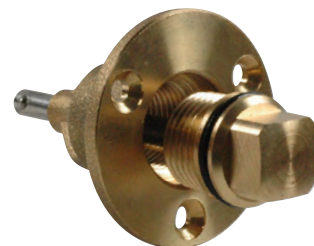

# Garboard Drains

## CAPTIVE PLUG OVAL GARBOARD DRAIN

The two unique oval captive plug garboards use the same 316 stainless steel housing with either a stainless steel or plastic plug. Both incorporate an o-ring for positive sealing and a mechanism that allows them to drain water without removal –preventing loss.

Part No.	Type	Size	Flange	Material	
				Flange	Plug
GARBO.500S-P-LOCK	Ass'y	1/2"	1.5"x 2"	S.S.	Plastic
GARBO.500S-S-LOCK	ASS'y	1/2"	1.5"x 2"	S.S.	S.S.



## DRAIN TUBE AND EXPANDABLE PLUGS

Standard one inch drain tube for transoms and outboard wells. Threaded T-handle or flip-lock expandable drain plugs are available.

Part No.	Size
GARB1.00-Tube	1"
GARB1.00-T-Handle	1"
GARB1.00-Flip-Plug	1"

## T-HANDLE GARBOARD DRAINS

The T-handle garboard drain assembly is designed specifically for competition ski boats, with their unique hull and interior configurations. The flange is threaded from the back side so the plug can fit inside the boat. The 1/2" size has three mount holes, the 3/4" size has four —all with #8 fasteners. The T-handle is long and easily accessible, to avoid fumbling through dirty bilge water. It also incorporates a hex for wrench operation. The plug is solid to prevent freeze damage.

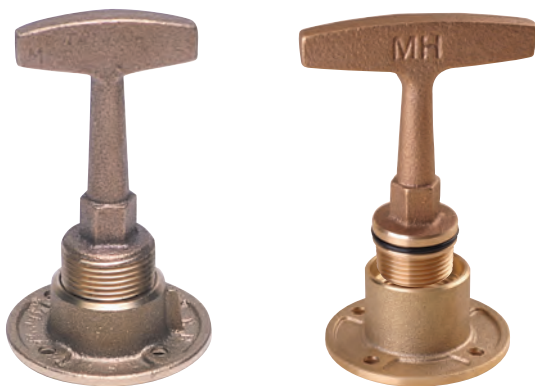

Part No.	Type	Size	Flange O.D.	Material	
				Flange	Handle
GARBO.500-T	Assembly	1/2"	2"	Brass	Bronze
GARBO.500-TS	Assembly	1/2"	2"	S.S.	Bronze
GARBO.750-T	Assembly	3/4"	2-1/4"	Brass	Bronze
PLUG0.500-T	T-handle only	1/2"	2"	N/A	Bronze
PLUG0.750-T	T-handle only	3/4"	N/A	N/A	Bronze
FLNG0.500-T	Flange only	1/2"	2"	Brass	N/A
FLNG0.750-T	Flange only	3/4"	2-1/4"	Brass	N/A

The o-ring model creates a water tight seal without having to tighten threads with a wrench.

Part No.	Type	Size	Flange O.D.	Material	
				Flange	Plug
GARBO.750-T-OR	Assembly	3/4"	2-1/4"	Brass	Brass

# Clamps

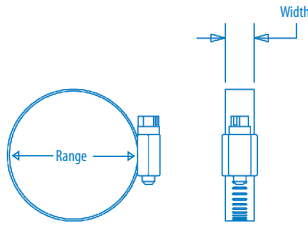

## HOSE CLAMPS

All clamps have stainless steel band and components.

Part No.	SAE	Width	Range
HSCP6D0616	MINI #4	5/16"	1/4"–5/8"
HSCP6D0822	MINI #6	5/16"	5/16"–7/8"
HSCP5D1022	#06	1/2"	3/8"–7/8"
HSCP5D1125	#08	1/2"	7/16"–1"
HSCP5D1427	#10	1/2"	1/2"–1-1/16"
HSCP5D1332	#12	1/2"	1/2"–1-1/4"
HSCP5D1832	N/A	1/2"	11/16"–1-1/4"
HSCP5D1838	#16	1/2"	11/16"–1-1/2"
HSCP5D1870	N/A	1/2"	11/16"–2-3/4"
HSCP5D2144	#20	1/2"	3/4"–1-3/4"
HSCP5D2751	#24	1/2"	1"–2"
HSCP5D3357	#28	1/2"	1-1/4"–2-1/4"

Part No.	SAE	Width	Range
HSCP5D4063	#32	1/2"	1-1/2"–2-1/2"
HSCP5D4670	#36	1/2"	1-3/4"–2-3/4"
HSCP5D5276	#40	1/2"	2"–3"
HSCP5D5782	#44	1/2"	2-1/4"–3-1/4"
HSCP5D6489	#48	1/2"	2-1/2"–3-1/2"
HSCP5D7095	#52	1/2"	2-3/4"–3-3/4"
HSCP5D76101	#56	1/2"	3"–4"
HSCP5D84108	#60	1/2"	3-1/4"–4-1/4"
HSCP5D64114	#64	1/2"	2-1/2"–4-1/2"
HSCP5D76127	#72	1/2"	3"–5"
HSCP5D92140	#80	1/2"	3-1/2"–5-1/2"
HSCP5D108152	#88	1/2"	4"–6"

# Nylon Wire Ties

## NYLON WIRE TIES w/Mounting Holes

Part No.	Nominal Length	Size WxL	Pcs/Bag	Bags/Ctn	Color
WRTS20001	4"	.10"x3.94"	100	250	Black
WRTS20002	6"	.142"x5.9"	100	250	Black
WRTS30001	8"	.189"x7.87"	100	250	Black
WRTS30002	12"	.31"x11.8"	100	250	Black

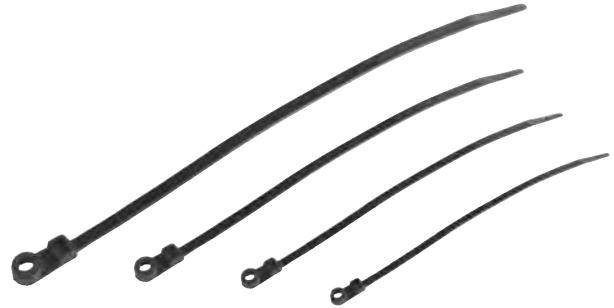

## NYLON WIRE TIES

Part No.	Nominal Length	Size WxL	Pcs/Bag	Bags/Ctn	Color
WRTS40001	5-3/4"	.189"x 6.3"	100	250	Black
WRTS40002	7"	.189"x 7"	100	250	Black
WRTS40003	8"	.189"x 7.87"	100	250	Black
WRTS40004	8"	.189"x 7.87"	100	250	White
WRTS40005	11"	.189"x 11"	100	250	Black
WRTS40006	14"	.189"x 13.75"	100	250	Black
WRTS40007	15"	.189"x15"	100	250	Black
WRTS40008	15-1/2"	.189"x 15.75"	100	250	White
WRTS40009	16"	.189"x 15.75"	100	250	Black

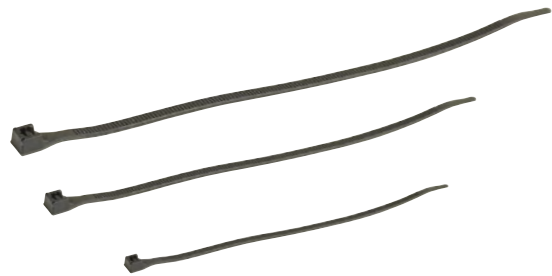

### TIE MOUNT

WRTS10001, please see page 85.

# Lighting

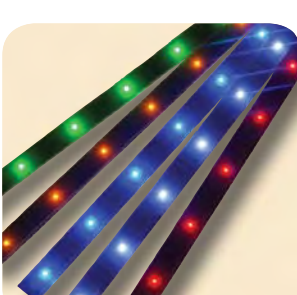
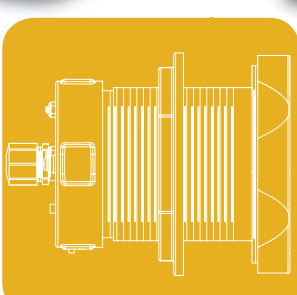
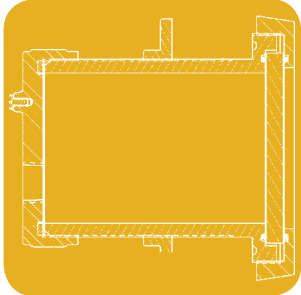

# Underwater Lights

Marine Hardware,™ Inc. offers a selection of cast 316 stainless steel underwater lights with maintenance friendly features. These light sources can be used individually or with several others to provide underwater illumination for a striking nighttime appearance at night. Besides the night-time ambiance, these lights are engineered for safety, with water jacket thermal dissipation and an internal over-temperature shutoff switch to ensure that neither the light surrounding objects overheat. These lights are manufactured of 316 stainless steel, with a brightly polished exterior ring securing the borosilicate lens with generous beam opening. The assemblies install in the same manner as a typical thru-hull fitting. Design features include a stainless steel power cord strain relief, a stainless steel security cap, and wrench flats on the internal threads for easy tightening with a flanged nut.

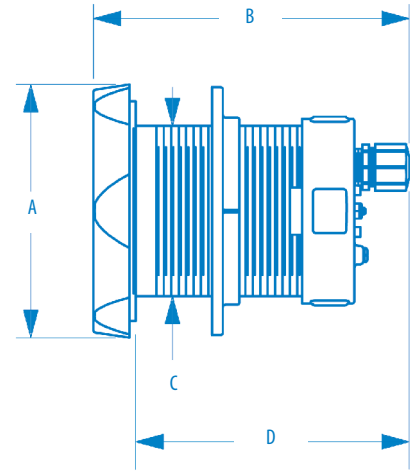

## 4" UNDERWATER HALOGEN LIGHTS-1,230 Lumens

For both fiberglass and metal hulls, these 55 watt halogen bulbs produce 1230 lumens. The 12V DC draw 5 amps, while the 24V DC draw 2.5 amps. Both are available with 3-1/2" x 3/8" borosilicate glass lens.

Part No.	Voltage	Overall Dia. (A)	Overall Length (B)	Instl. Hole Dia. (C)	Instal. Depth (D)	Thread Depth
SSUL90000	12	5-3/4"	6"	3-7/8"	5"	4"
SSUL90024	24	5-3/4"	6"	3-7/8"	5"	4"



## 4" UNDERWATER XENON LIGHTS-3,200 Lumens

For both fiberglass and metal hulls, these 35 watt Xenon bulbs produce 3,200 lumens. The 12V DC draw 2.92 amps, while the 24V DC draw 1.46 amps. Both are available with 3-1/2" x 3/8" borosilicate glass lens.

Part No.	Voltage	Overall Dia. (A)	Overall Length (B)	Instl. Hole Dia. (C)	Instal. Depth (D)	Thread Depth
SSUL90000-XIB	12	5-3/4"	6"	3-7/8"	5"	4"
SSUL90024-XIB	24	5-3/4"	6"	3-7/8"	5"	4"



## 4" UNDERWATER HALIDE LIGHT-5,500 Lumens

For both fiberglass and metal hulls, this 70 watt metal halide bulb produces 5,500 lumens. The 12V DC draws 14 amps. Available with 3-1/2" x 3/8" borosilicate glass lens.

Part No.	Voltage	Overall Dia. (A)	Overall Length (B)	Instl. Hole Dia. (C)	Instal. Depth (D)	Thread Depth
SSUL90000-MH70	12	5-3/4"	7-1/8"	4"	6-1/2"	3-1/8"

# Underwater Lights

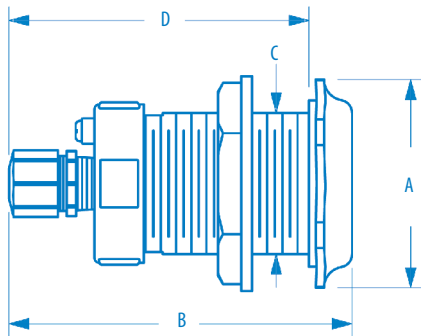

## 2" UNDERWATER HALOGEN LIGHTS-1,000 Lumens

For both fiberglass and metal hulls, these 20 watt halogen bulbs produce 1000 lumens. The 12V DC draw 1.67 amps, while the 24V DC draw .84 amps. Both are available with 2-1/2" x 1/4" borosilicate glass lens.

Part No.	Voltage	Flange Dia (A)	Overall Length (B)	Instl. Hole Dia. (C)	Instal. Depth (D)	Thread Depth
SSUL20000	12	3-5/8"	4-1/2"	2-1/4"	3"	2-7/8"
SSUL20024	24	3-5/8"	4-1/2"	2-1/4"	3"	2-7/8"

## 2" UNDERWATER XENON LIGHT-2,500 Lumens

For both fiberglass and metal hulls, this 21 watt Xenon bulb produces 2500 lumens. The 12V DC draw 1.75 amps. Available with 2-1/2" x 1/4" borosilicate glass lens.

Part No.	Voltage	Overall Dia. (A)	Overall Length (B)	Instl. Hole Dia. (C)	Instal. Depth (D)	Thread Depth
SSUL20000-X	12	3-1/4"	4-1/2"	2-1/4"	3"	2-7/8"

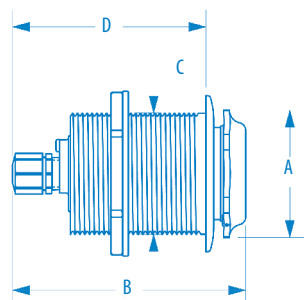

## WATER - JACKETED UNDERWATER LIGHT

For both fiberglass and metal hulls, this 50 watt Halogen bulb produces 1100 lumens. The 12V DC draws 4.1 amps. Available with 2-1/2" x 6.5mm borosilicate glass lens.

Part No.	Voltage	Overall Dia. (A)	Overall Length (B)	Instl. Hole Dia. (C)	Instal. Depth (D)	Thread Depth
SSUL21000	12	3-1/4"	6"	3-1/8"	5"	3"

# Interior Lights



Note -Twist lock is intended for temporary lock while adhesive cures during assembly.



## LED COURTESY LIGHTS

Marine Hardware,™ Inc.'s unique flush mount courtesy lights come with a removable 304 stainless steel cover with no visible fasteners. The water proof design includes 2-#6 mounting screws and a 12" power cord. Available in white, amber, blue, red, and green lenses. Available in 12 volt or 24 volt.

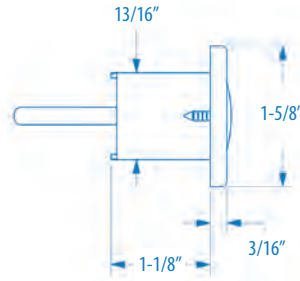

Part No.	Color	Volts
SSIL10002-AM	Amber	12 V
SSIL10002-BL	Blue	12 V
SSIL10002-GR	Green	12 V
SSIL10002-RD	Red	12 V
SSIL10002-WH	White	12 V
SSIL10002-24V-AM	Amber	24 V
SSIL10002-24V-BL	Blue	24 V
SSIL10002-24V-GR	Green	24 V
SSIL10002-24V-RD	Red	24 V
SSIL10002-24V-WH	White	24 V

## LED STRIP LIGHTS - Soft Molded

These waterproof L.E.D. strip lights feature the performance characteristics of LED lighting in a soft flexible urethane strip. This flexible strip is 1/8" thick and a 1/2" wide allowing it to be wrapped around curved surfaces and has LED lights embedded every 1-1/4". The material can be fastened with double face adhesive tape which is included. Because of the milliamps of current used to power the lights, they do not generate heat. Strips can be cut to exact sizes, depending on your application. Available in 12 volt or 24 volt.

Part No.	Color	Length	Voltage
LITELED12V-12IN-AM	Amber	12"	12V
LITELED12V-12IN-BL	Blue	12"	12V
LITELED12V-12IN-GR	Green	12"	12V
LITELED12V-12IN-RD	Red	12"	12V
LITELED12V-12IN-WH	White	12"	12V
LITELED12V-24IN-AM	Amber	24"	12V
LITELED12V-24IN-BL	Blue	24"	12V
LITELED12V-24IN-GR	Green	24"	12V
LITELED12V-24IN-RD	Red	24"	12V
LITELED12V-24IN-WH	White	24"	12V
LITELED12V-36IN-AM	Amber	36"	12V
LITELED12V-36IN-BL	Blue	36"	12V
LITELED12V-36IN-GR	Green	36"	12V
LITELED12V-36IN-RD	Red	36"	12V
LITELED12V-36IN-WH	White	36"	12V
LITELED12V-48IN-AM	Amber	48"	12V
LITELED12V-48IN-BL	Blue	48"	12V
LITELED12V-48IN-GR	Green	48"	12V
LITELED12V-48IN-RD	Red	48"	12V
LITELED12V-48IN-WH	White	48"	12V

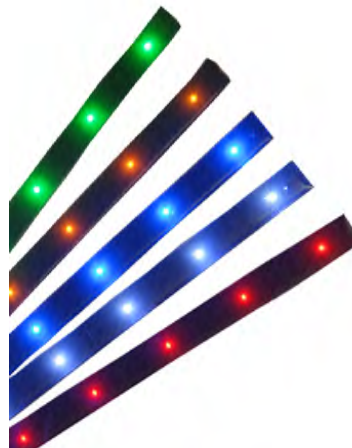

Part No.	Color	Length	Voltage
LITELED24V-12IN-AM	Amber	12"	24V
LITELED24V-12IN-BL	Blue	12"	24V
LITELED24V-12IN-GR	Green	12"	24V
LITELED24V-12IN-RD	Red	12"	24V
LITELED24V-12IN-WH	White	12"	24V
LITELED24V-24IN-AM	Amber	24"	24V
LITELED24V-24IN-BL	Blue	24"	24V
LITELED24V-24IN-GR	Green	24"	24V
LITELED24V-24IN-RD	Red	24"	24V
LITELED24V-24IN-WH	White	24"	24V
LITELED24V-36IN-AM	Amber	36"	24V
LITELED24V-36IN-BL	Blue	36"	24V
LITELED24V-36IN-GR	Green	36"	24V
LITELED24V-36IN-RD	Red	36"	24V
LITELED24V-36IN-WH	White	36"	24V
LITELED24V-48IN-AM	Amber	48"	24V
LITELED24V-48IN-BL	Blue	48"	24V
LITELED24V-48IN-GR	Green	48"	24V
LITELED24V-48IN-RD	Red	48"	24V
LITELED24V-48IN-WH	White	48"	24V

# Custom Lighted Logos-Letters

## LIGHTED LOGOS/DESIGNS/LETTERS

These custom designs incorporate an acrylic mounting plate, CNC routed, to accent the soft molded LED light strips and covered by a decorative stainless steel cover. Sandwiched together, this offers a unique light with decorative appeal. Contact Marine Hardware,™ Inc. with your logo or design or other light projects you might need built.

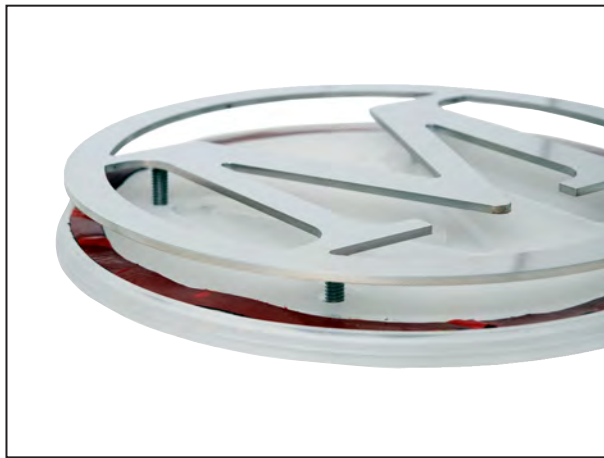

Assembly of exterior light is waterproof.  
Available in 12 volt or 24 volt.



Any laser cut stainless letters can be accented to add a signature look to any boat.

## LED STRIP LIGHTS-Custom Molded

When you are trying to light with LED water proof either 12 or 24 volts, our simple style as straight but custom molded for your application. All colors available.

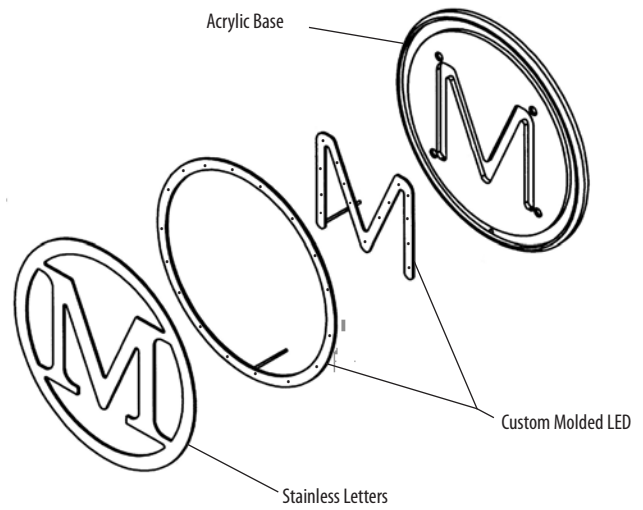

Multiple colors available just like our soft molded lights. As shown on opposite page

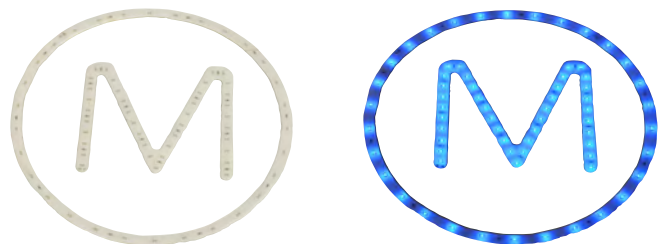

# Concept ...

# Production ...

# Fullfillment...

## CAD...

Send us a blueprint, a computer file, or a sketch on a cocktail napkin — we can build it. A typical job begins in our design department where we virtually create your part on a computer system utilizing Unigraphics CAD/CAM 5-axis software. From our design department, the file moves to our rapid prototype area where we operate two different kinds of solid object printers. When the design is approved, we can build patterns and tooling for several types of castings, from investment (lost wax) to sand castings.



## Inspection...

Once the design team is done our inspection process begins. With inbound inspections for metal chemistry, routine salt spray testing and documentation control.



## Fullfillment...

We pride ourselves on our 99% on-time delivery. We utilize advanced inventory controls and bar-coding.

With three warehouses:

- Redmond, Washington
- Ormond Beach, Florida
- Manistee, Michigan

we support OEM production on the entire continent.



# Deck Hardware

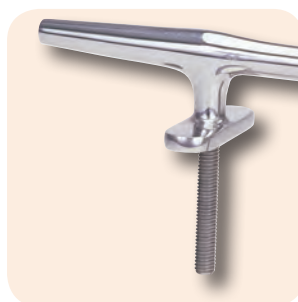
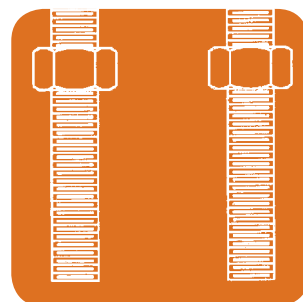
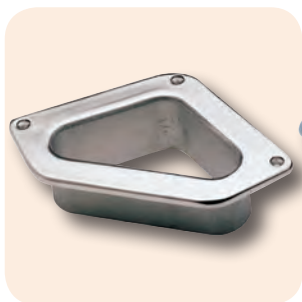
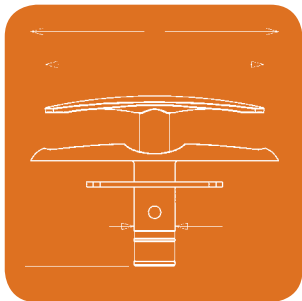
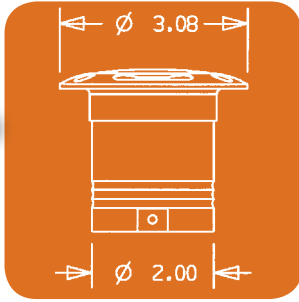
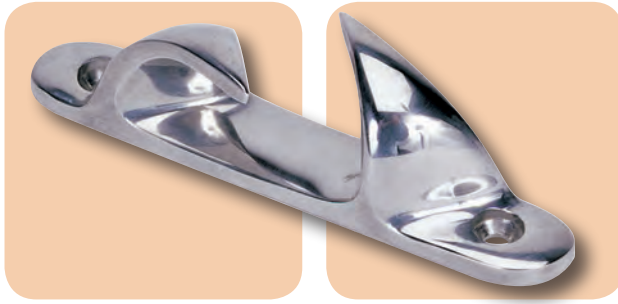
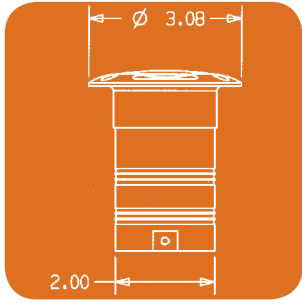

# Pull-Up Cleats



## DUAL POST PULL-UP CLEAT Patent # 6,588,355

Cast 316 stainless steel, unique damper bushing allows for smooth operation without vibration or rattle. Available in three sizes with custom logos for some applications. *Manufactured under license by Attwood.*

Part No.	A	B	C	D	E	F
SSCL80500	4-3/4"	4-5/16"	2"	1-3/4"	1-3/8"	15/16"
SSCL80700	6-1/4"	5-1/2"	2"	2-1/4"	1-1/2"	15/16"
SSCL80900	8"	7"	2"	2-1/4"	1-7/8"	15/16"
SSCL80900-HD	8"	7"	2"	2-13/16"	1-7/8"	15/16"
DRAINBOOT-1.75-KIT	Drainboot for SSCL80500					
DRAINBOOT-2.25-KIT	Drainboot for SSCL80700 and SSCL80900					
DRAINBOOT-2.81-KIT	Drainboot for SSCL80900-HD					

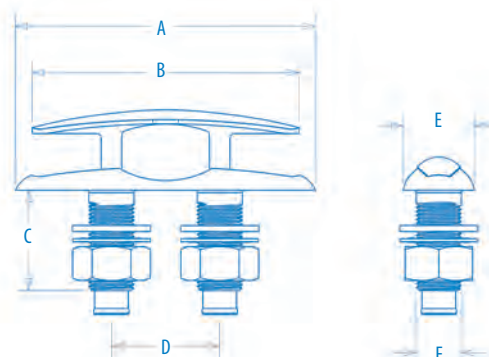

## SINGLE POST PULL-UP CLEAT

Cast 316 stainless steel with single post for quick installation. Electro-polished with bright polished top surfaces. Fasteners are hidden and the cleat is flush to the base. The base is cast with a sealant pocket. Custom backing plates and drain boots are available.

Part No.	A	B	C	D	E
SSCL80450	5"	4-5/16"	3-5/8"	1-3/8"	1"
SSCL80600	6-1/4"	5-1/2"	3-5/8"	1-1/2"	1"
SSCL80800	8-3/8"	7-1/2"	3-5/8"	2"	1"
DRAINBOOT-1.00	Drainboot for above single post cleats				

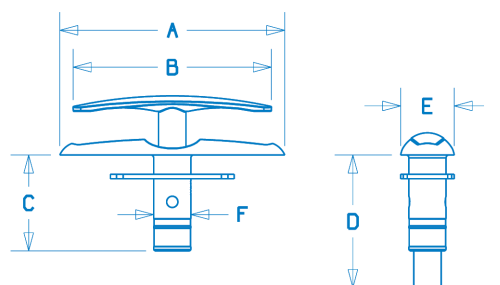

# Pull-Up Cleats

## PULL-UP CLEAT - Stud Mount

Stud mount for smoothest appearance and to prevent dirt and rust accumulation in screw heads. Investment cast 316 stainless steel. Bright polished on all appearance surfaces. Ball lock in up position, for rigidity. Special design to minimize rattle in both up and down positions. Shipped with gasket and aluminum backing plate shaped to match. Drain fitting (1/4" NPT thread x 3/8" hose) included for hose connection to drain into bilge.

Part No.	Length	Fasteners
SSCL70100-PU	4-1/2"	1/4"-20 Stud
SSCL70000-PU	6"	1/4"-20 Stud
SSCL70200-PU	8"	1/2"-13 Stud



## PULL-UP CLEAT - Hole Mount

Hole mount for those who prefer the security of four fasteners. Investment cast 316 stainless steel. Bright polished on all appearance surfaces. Ball lock in up position, for rigidity. Special design to minimize rattle in both up and down positions. Shipped with gasket and aluminum backing plate shaped to match. Drain fitting (1/4" NPT thread x 3/8" hose) included for hose connection to drain into bilge.

Part No.	Length	Fasteners
SSCL70101-PU	4-1/2"	1/4"-20
SSCL70001-PU	6"	1/4"
SSCL70201-PU	8"	1/4"



## PULL-UP FENDER CLEAT-Patented

Our unique style of single post retractable fender cleat is investment cast of 316 stainless steel. This unit is designed with a detent area so that the cleat stays up or stays down as desired, and does not rattle. The cleat swivels from the base at one discrete point for easy power-tool installation with two screws through the base. These fasteners are "hidden" and the cleat is flush to the base when in retracted position. Unit is styled with smooth lines which will not inadvertently catch lines or stub toes. Custom backing plates available by special order. Drain boot available.

Part No.	Length	Fasteners		Hole dia.	Lift Height
		Qty	Type		
SSCL80000-FENDER	4"	2	#10	7/8"	1/2"

This cleat is not designed for mooring. Patented: US D483,247 S

## RETRACTABLE FENDER CLEAT

Unique single post design with extended threads, easily mounts in all applications. Bottom head design compliments all boat designs. Investment cast 316 stainless steel.

Part No.	Extended Length	Retracted Length
SSCL80175-RND-FENDER	1-1/8"	1/2"



# Euro Cleats

Marine Hardware,™ Inc., cleats are manufactured with 316 stainless steel, chromic polished and passivated for a bright long lasting finish. Material has a minimum tensile strength of 100,000 ksi. All holes are machine drilled and 82° counter sunk for flat or oval head fasteners. Backing plates available for cleats, call or e-mail for details.



## EURO STYLE CLEATS - Stud Mount

Investment cast 316 stainless steel. Bright polished. Machined flat base for flush mounting on the deck. Euro-style body for a smooth, contemporary look. Heavier body than the standard hollow-base Herreshoff style. "Blind" stud mounting system affords a smooth appearance and prevents rust and dirt accumulation in screw heads. Custom backing plates available by special order .

Part No.	Length	Height	Stud
SSCL66009-2SE	6"	1-1/2"	5/16"
SSCL66010-2SE	8"	1-5/8"	5/16"
SSCL66011-2SE	10"	2-1/8"	1/2"
SSCL66012-2SE	12"	2-1/2"	1/2"

## EURO STYLE CLEATS - Feet Mount

Investment cast 316 stainless steel for greatest strength and corrosion resistance. Finely detailed bright polishing, as expected for mega-yacht application. Euro-style body for smooth, contemporary styling. Four-hole mounting arrangement for those who prefer the strength of 4 fasteners rather than two studs. Custom backing plates available by special order.

Part No.	Length	Height	Fastener
SSCL66012-4HE	12"	2-3/8"	5/16"
SSCL66015-4HE	15"	3"	5/16"
SSCL66018-4HE	18"	3-5/8"	5/16"



## EVT CLEATS

Investment cast 316 stainless steel. Small pad mounting area for use on flat and curved surfaces. Flat top surface allows for easy installation of custom names and logos. Complete with stud and fasteners.

Part No.	Length	Height	Fastener
SSCL66009-2SEVTE	6"	1-5/32"	5/16"
SSCL66010-2SEVTE	8"	1-3/8"	7/16"
SSCL66011-2SEVTE	10"	1-13/16"	1/2"
SSCL66012-2SEVTE	12"	2-1/2"	5/8"

# Hollow Base Cleats

## HOLLOW BASE CLEATS-Standard

Herreshoff hole mounted 316 solid stainless cleats. Custom backing plates available by special order.

Part No.	Length	Height	Fastener
SSCL20004	4"	1"	#10
SSCL20005	5"	1-1/8"	1/4"
SSCL66009	6"	1-1/4"	1/4"
SSCL66010	8"	1-3/8"	1/4"
SSCL66011	10"	1-3/4"	5/16"
SSCL66012	12"	2-1/8"	5/16"



Hollow Base

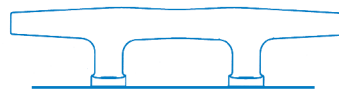

Heavy Duty Hollow Base

## HEAVY DUTY HOLLOW BASE CLEATS-Taller & Heavier

Herreshoff Style Heavy Duty, same as above but with 20% more metal overall than standard cleats, for superior strength. Investment cast 316 stainless steel. Bright polished. Machined flat base for flush mounting on the deck. Custom backing plates available by special order.

Part No.	Length	Height	Fastener
SSCL66010-HD	8"	1-3/4"	1/4"
SSCL66011-HD	10"	2"	5/16"
SSCL66012-HD	12"	3"	5/16"
SSCL66015	15"	4"	5/16"



## 2 - STUD HOLLOW BASE CLEATS

Same as Standard Cleats featuring stainless stud mounts. Intended to hide outside appearance of fastener head and the tendency for the screw heads to rust. Custom backing plates available by special order. We also have these available with a modified small foot. This allows for easy installation on all curved surfaces.

Part No.	Length	Height	Stud	Base Type
SSCL66019	6"	1-1/4"	1/4"	Small
SSCL66009-2S	6"	1-1/4"	5/16"	Standard
SSCL66010-2S	8"	1-3/8"	3/8"	Standard
SSCL66011-2S	10"	1-3/4"	5/16"	Standard
SSCL66012-2S	12"	2-1/8"	5/16"	Standard

## CHROME PLATED HOLLOW BASE CLEAT

Cast zinc, bright chrome polished, affordable with easy surface mount fasteners and a design that secures the line snug.

Part No.	Length	Height	Fasteners
SSCL30004	4-3/4"	1"	#8



# Custom Cleats

## CUSTOM CLEATS

From Marine Hardware,™ Inc.'s traditional style to our flush Euro style pull-up cleats, we manufacture an entire line of custom pull-up cleats for boat builders throughout the world. Contact our sales department with your ideas as a new style for your customers.



## Chocks

All of our Chocks are 316 investment cast stainless steel, the strongest and most corrosion resistant material available for deck hardware exposed to the rigors of a marine environment. Brightly polished for a flawless appearance.



### SKENE BOW CHOCKS

Part No.	Unit	Length	Line Size	Fastener
SSCH66113	Pair	4-1/2"	1/2"	#10
SSCH66073	Pair	6"	3/4"	1/4"



### BOW CHOCKS-Wide Opening

Part No.	Unit	Length	Line Size	Fastener
SSCH66013	Pair	4-1/2"	1/2"	#10
SSCH66030	Pair	6"	3/4"	1/4"
SSCH66053	Left	9"	1"	3/8"
SSCH66054	Right	9"	1"	3/8"



### STRAIGHT CHOCKS-Narrow Opening

Part No.	Unit	Length	Line Size	Fastener
SSCH66081	Ea.	4"	1/2"	#10
SSCH66082	Ea.	5"	5/8"	#10
SSCH66083	Ea.	6"	3/4"	1/4"

# Bollards

## BOLLARDS-Single Head Mounting Style

Fabricated 316 stainless steel, easy mounting with 1/2" diameter countersunk fasteners, custom heights available.

Part No.	Length	Width	Horn Height
SSBD90311	7-7/8"	4-3/8"	7-1/4"
SSBD90313	7-7/8"	4-3/8"	12"



## BOLLARDS-Dual Horn

Investment cast 316 stainless steel.

Part No.	Length	Width	Horn Tip
SSBD90000	12"	4"	14-1/4"
SSBD90100	17"	6"	20-3/8"

## BOLLARDS-Two Horn Fabricated Small Series

316 stainless steel for greatest strength and corrosion resistance. Finely detailed bright polishing, as expected for mega yacht application.

Part No.	Length	Width	Horn Tip	Studs
SSBD90310	10"	2-1/4"	10"	3/4"-10x3 Pls
SSBD90312	12"	3"	12-3/4"	3/4"-10x6 Pls



## BOLLARDS-Two Horn Fabricated Large Series

316 stainless steel for greatest strength and corrosion resistance. Finely detailed bright polishing, as expected for mega yacht application.

Part No.	Length	Width	Horn Tip	Studs
SSBD90480	13-1/2"	4"	19"	3/4"-10x3 Pls
SSBD90500	16"	5"	22"	3/4"-10x6 Pls



# Lifting Systems

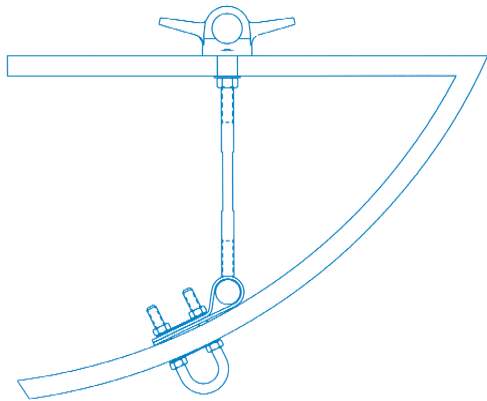

Marine Hardware,™ Inc. manufactures a complete lifting system assembly and offers individual components to meet your unique needs. All components are designed to work together. All threaded assemblies are CNC machined to ensure maximum strength. Mounting brackets are fabricated type 304. Deck fittings are type 316 investment cast.

## LIFTING RINGS/CLEATS

316 investment cast stainless steel for greatest strength and corrosion resistance. Bright polished. 6" size for lifting up to 4,000 lbs. , 7" size is heavy-duty, with 50% more metal overall than the 6" size. Rated for lifting up to 6,000 lbs.

Part No.	Length	Diameter
SSRI66098	6"	1-1/8"
SSRI66099	7"	1-1/2"
SSRI66058	2-9/16"	1-11/32"



## KEEL PLATES

Part No.	Accommodates Bow Eye Size
SSRIKEEL-PLATE	1/2" or 3/8"
SSRIKEELPLT-58	5/8"
SSRIKEELPLT-LH	5/8" Left-hand Thread

## LIFTING RODS

Stainless steel hex rod is threaded at both ends to go between lifting eye and keel plate. Contact us for production quantities in custom lengths.



Part No.	Length	Thread
LIFT-ROD-0.62RL-11	11"	Left
LIFT-ROD-0.62RL-12	12"	Left
LIFT-ROD-0.62RL-18	18"	Left
LIFT-ROD-0.62RR-11	11"	Right
LIFT-ROD-0.62RR-18	18"	Right

## VECTOR LIFTING EYE

Investment cast 316 bright polished.

Part No.	Base Size	Height	Eye ID
SSRI66059	3-11/32" X 5"	2-7/8"	1-1/2"



## FLUSH TRANSOM EYE

Investment cast 316 bright polished.

Part No.	Base Size	Height
SSSE10002	1-13/32" X 4"	1-13/32"



# Bow & Stern Eyes

Marine Hardware,™ Inc. offers a wide range of eyes to meet your every need. Our bow eyes are standard with radius end. Backing plates to fit all bow stems. Our stern eyes come with rectangle backing plates to fit all flat transoms. Standard eyes are made from 304 stainless. 316L is available on request. All eyes are rolled threads, standard bright finish is mechanically polished and passivated to offer maximum rust and corrosion protection.

## BOW EYES

Tested to min. 85,000 lbs/sq inch tensile strength, bright polished.  
Long nose available for special trailer applications. Type 304 stainless.

Part No.	Nom. Diameter	Thread Length (A)	Overall Length (B)	Spread (C)	Lock Washer	Nylon Full Nut
SSRI66405	3/8"	1-1/4"	3"	1-7/16"	No	No
SSRI66400	3/8"	2-5/16"	3-15/16"	1-3/16"	No	No
SSRI66401	3/8"	2-3/4"	4-1/2"	1-7/16"	No	No
SSRI66402	3/8"	3-1/4"	5"	1-7/16"	Yes	No
SSRI66403	3/8"	2-1/4"	4"	1-7/16"	No	No
SSRI66504	3/8"	2-3/4"	4-1/2"	1-13/32"	No	No
SSRI66501	3/8"	2-3/4"	5"	1-13/32"	No	Yes
SSRI66503	3/8"	3-11/16"	5-7/16"	1-7/16"	No	No
SSRI66068	1/2"	2-1/4"	4-1/4"	1-7/8"	No	No
SSRI66082	1/2"	2-1/2"	4-21/32"	1-13/16"	No	No
SSRI66083	1/2"	3"	5"	1-13/16"	Yes	No
SSRI66342	1/2"	3-1/4"	5-1/4"	1-13/16"	No	Yes
SSRI66070	1/2"	3-1/4"	5-5/16"	1-7/8"	No	No
SSRI66080	1/2"	3-1/4"	5-5/16"	1-7/8"	Yes	No
SSRI66071	1/2"	3-3/4"	5-13/16"	1-7/8"	No	No
SSRI66081	1/2"	3-3/4"	5-7/8"	1-13/16"	No	No
SSRI66343	1/2"	4-1/2"	6-5/8"	1-3/4"	No	No
SSRI70000	5/8"	5"	8"	1-13/16"	No	No

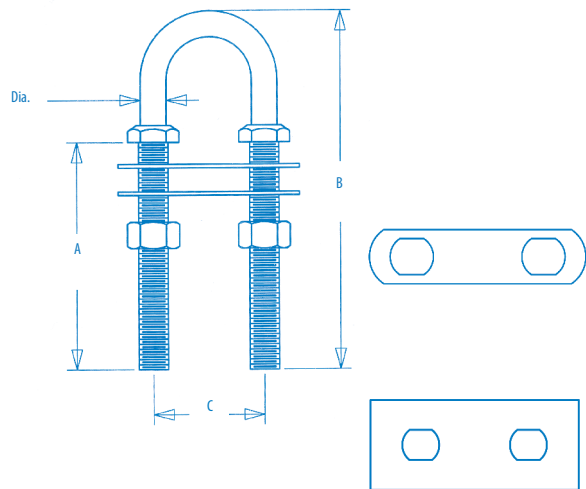

Typical Stern Eye Plate

## STERN EYES

Tested to min. 85,000 lbs/sq inch tensile strength, bright polished.  
Complete with rectangle backing plate.

Part No.	Nom. Diameter	Thread Length (A)	Overall Length (B)	Spread (C)
SSSE10001	1/2"	2-1/4"	4-5/16"	1-13/16"
SSSE10003	3/8"	3-3/4"	5-1/2"	1-13/32"
SSSE10001-RBP	Rectangle backing plate for SSSE10001			
SSSE10003-OBP	Oval backing plate for SSSE10003			
SSSE10003-RBP	Rectangle backing plate for SSSE10003			



## BOW PLATE w/BOW EYE

Marine Hardware,™ Inc. manufactures custom bow plates for all OEM applications. Welded bow eyes ensure corrosion protection and beauty. Available in 304 or 316 stainless steel.

# Hawse Pipes/Cleats

Hawse pipes are made of 316 investment cast stainless steel, bright polish top and smooth inside to prevent lines from chafing.



## LARGE OVAL HAWSE PIPE

Investment cast 316 stainless steel, bright polished.

Part No.	Int. Hole	Depth	Fastener
SSDP66009	6-1/4" x 2-7/8"	1-3/4"	#10

## SMALL OVAL HAWSE PIPE- Stud Mounted

Stud mounted for a smooth contemporary style. Investment cast 316 stainless steel.

Part No.	Int. Hole	Depth	Fastener
SSDP66010	3-3/4" x 1-3/4"	1-1/4"	#10



SSDP66011



SSDP66349

## HAWSE PIPES

Investment cast 316 bright polished, machined finish for fasteners

Part No.	Int. Hole	Depth	Fastener
SSDP66349	5" x 2-3/4"	1-3/4"	#10
SSDP66011	4-9/32" x 2-3/4"	1-3/32"	#10

## HAWSE CLEATS & RINGS

316 investment cast stainless steel for greatest strength and corrosion resistance. Finely detailed bright polishing, as expected for mega-yacht application. Available with or without horns, for any hawse pipe application. Standard neck length as shown can be modified to custom hull thickness requirements. Can be cut to your specified length in our factory or in your shop. Backing plate has blind holes to present a smooth, clean appearance on the outboard side of the boat.

Part No.	Dimensions	Horn Tip
SSH80000	4" x 6"	17-1/4"
SSH80100	5" x 10"	25"
SSH80200	6" x 12"	32"
SSHR80000	4" x 6"	N/A
SSHR80100	5" x 10"	N/A
SSHR80200	6" x 12"	N/A



# Scuppers

## SCUPPERS - Ball Type

A traditional ball type scupper available in 1-1/2" and extra large 2 inch versions, both are cast stainless steel with removable grates.

Part No.	Description	Hose Size
SSSC15000	Ball-type cockpit scupper	1-1/2"
SSSC20000	Ball-type cockpit scupper	2"



## SCUPPER - Oval

Cast stainless steel and mirror polished, this scupper adds class to the cockpit of any fishing or cruising boat. Fits 1-1/2 inch hose and has a removable grate for cleaning.

Part No.	Description
SSSC15005	Oval Cockpit Scupper for 1-1/2" hose

## CUSTOM DRAIN SCUPPERS

Let us build you the perfect deck drain for your boat. Available in cast or fabricated stainless steel, spring tabs or threads to fit your specific application.



# Deck Pipe

## CHAIN AND ROPE DECK PIPE

The large oval opening accommodates anchor rope, thimble and chain. The hinged cover can be locked in the open position. Construction is all stainless steel with a mirror polished cover and flange.

Part No.	Width	Length	Overall Height
SSDP66008	3-15/16"	5-9/16"	2"



# Deck Fills



DIESEL



WATER



WASTE



GAS



OIL

## DECK FILLS with KEY

Investment cast 316 stainless steel. Assembly is complete with fill, cap, chain and key. Same font used for all embossed labels for a consistent appearance. CNC threads on flange and cap for smooth operation. Cast-in sealant groove on underside of flange. Positive seal o-ring fits in groove of cap, won't fall out when cap is removed.

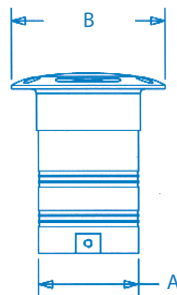
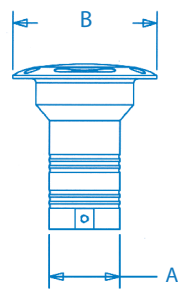

Part No.	Hose Size	Flange O.D.	Neck Length	Type	Chain	Fastener
	(A)	(B)	(C)			
SSDF66124	1-1/2"	3-1/8"	3-1/4"	Diesel	Yes	#10
SSDF66125	1-1/2"	3-1/8"	3-1/4"	Water	Yes	#10
SSDF66126	1-1/2"	3-1/8"	3-1/4"	Waste	No	#10
SSDF66127	1-1/2"	3-1/8"	3-1/4"	Gas	Yes	#10
SSDF66128	1-1/2"	3-1/8"	3-1/4"	Oil	Yes	#10
SSDF66394	2"	3-1/8"	3-1/4"	Gas	Yes	#10
SSDF66395	2"	3-1/8"	3-1/4"	Diesel	Yes	#10
SSDF66396	2"	3-1/8"	3-1/4"	Water	Yes	#10

Replacement cap SSDF66399 for the above, see page 40.

DECK  
HARDWARE

## DECK FILLS - Toggle Cap

Toggle cap deck fills have a handle in the flush cap for convenient removal without tools. The unique design is leak proof and interchangeable with caps on other Marine Hardware,™ Inc. deck fills.

Part No.	Hose Size	Flange O.D.	Neck Length	Type
	(A)	(B)	(C)	
SSDF66124-TC	1-1/2"	3-1/8"	3-1/4"	Diesel
SSDF66125-TC	1-1/2"	3-1/8"	3-1/4"	Water
SSDF66126-TC	1-1/2"	3-1/8"	3-1/4"	Waste
SSDF66127-TC	1-1/2"	3-1/8"	3-1/4"	Gas

Replacement cap SSDF66402 for the above, see page 40.

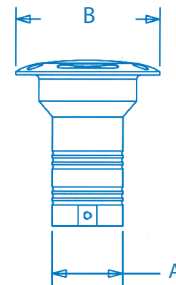

# Deck Fills

## HAND CAP - DECK FILLS

The hand cap is keyless, and has a special recess on its underside which enables it to fit over all our deck fill flanges. It hugs close to the deck without actually making contact which might mar the deck. It can be ordered as an assembly with fill body, or separately as a replacement part (includes ball chain). Its highly polished low dome cap affords a neat, smooth appearance, and the knurled edge gives a good finger grip even when wet. The extra long chain allows this larger cap to be moved completely out of the way of fill nozzles, without scratching the deck.

Part No.	Hose Size	Flange O.D.	Neck Length	Type	Chain	Cap	Fastener
	(A)	(B)	(C)				
SSDF66127-LC	1-1/2"	3-1/2"	3-1/4"	Gas	Yes	Hand	#10
SSDF66394-LC	2"	3-1/2"	3-1/4"	Gas	Yes	Hand	#10

Replacement cap SSDF66400 for the above, see page 40.

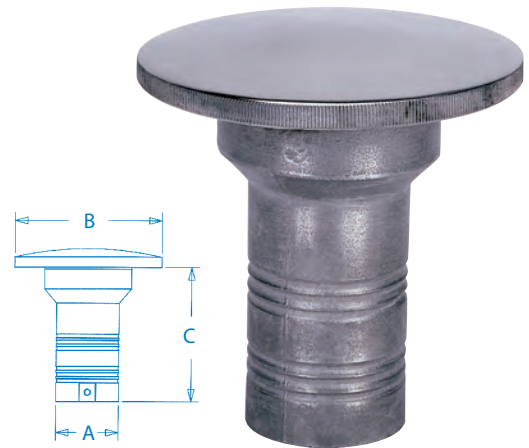

## DECK FILL - 2" Angle Neck

Refueling is made easier on the side gunnel and transom installations with this angled neck fill. The large neck size handles high capacity pumps.

Part No.	Hose Size	Angle	Type
SSDF005096	2"	45°	Gas

Replacement cap SSDF66400 for the above, see page 40.



SSDF66394-SHORT



SSDF66394-SHORT-LC

## 2" SHORT DECK FILL

This unique short design was inspired by ski boat applications. The 2" diameter size affords high-volume filling of the tank. The short length allows for maximum height fuel tanks in ski boats where tank is mounted behind seats. This model can use the same flush cap and key as our other deck fills, or the hand-cap. In stock in "Gas" only. Other label types may be tooled by special order for your production needs.

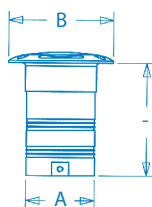

Part No.	Hose Size	Flange O.D.	Neck Length	Type	Chain	Cap	Fastener
	(A)	(B)	(C)				
SSDF66394-SHORT	2"	3-1/8"	2-3/8"	Gas	Yes	Keyed	#10
SSDF66394-SHORT-LC	2"	3-1/2"	2-3/8"	Gas	Yes	Hand	#10

Replacement cap SSDF66399 for SSDF66394-SHORT, see page 40.

Replacement cap SSDF66400 for SSDF66394-SHORT-LC, see page 40.

# Replacement Parts

## REPLACEMENT CAP- w/ Chain

Cast 316. 6" ball chain.

Part No.
SSDF66399



## TOGGLE REPLACEMENT CAP

Cast 316. 6" ball chain.

Part No.
SSDF66402



## BIG REPLACEMENT CAP

Cast 316. 6" cable.



Part No.
SSDF66400

## SPLASH GUARD FOR FUEL FILL

The cast 316 stainless steel splash guard fits under the flange of our 1-1/2" standard and toggle cap fills. It helps prevent fuel overflow from entering the cockpit.

Part No.
SSDF100200

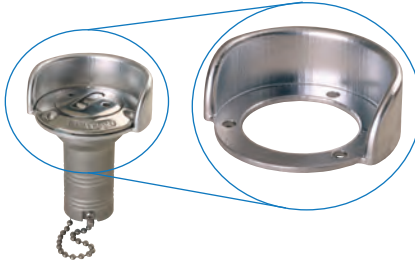

## REPLACEMENT KEY - Deck Fill

Investment cast 316 stainless steel. Fits 1-1/2" and 2" deck fills.

Part No.
SSDF66060



# Deck Plates

## DECK PLATES

Mirror polished, cast stainless steel, this deck plate has an o-ring for water resistant seal.

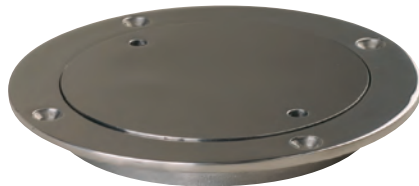

Part No.	Inner Dim.	Outer Dim.	Cutout Size
SSDP110044	3"	4-5/8"	3-3/8"
SSDP110144	4"	5-9/16"	4-3/8"
SSDP110244	5"	7-5/16"	5-3/8"
SSDP110344	6"	8-1/2"	6-1/2"

## WASHDOWN DECK PLATE

A stainless steel deck plate conceals the valve for this washdown outlet. Useful for either fresh or salt water washdown or as a fresh water inlet, this unit comes complete with an o-ring seal and deck plate key.

Part No.	Size
SSDF-60000	2-1/2"



## REPLACEMENT KEYS - Deck Plate

Marine Hardware,™ Inc. offers a variety of deck plate keys to fit plates of all sizes and types. The hinged type fits deck plates up to six inches in diameter. The universal type includes a bottle opener and a shackle wrench. All have durable stainless steel construction.

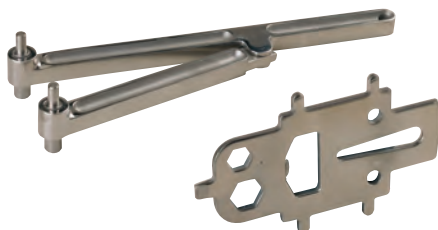

Part No.	Description
SSDF66056	Hinged
SSDF-66058	Universal

# Drink Cup Holders

Marine Hardware,™ Inc.'s fabricated drink cup holders are all manufactured from 304 stainless steel or special order 316. All include a double rolled top surface, bright polished top and made to precision standards to fit accurately. Extra wide 4-1/4" flange for easy installation. Available in single stack or double stack designs. All our stamped cup holders are available with optional gaskets, drains, or base pads.

## DRINK CUP HOLDER-Single Stack

Part No.	Depth	Cup Width
SSDC70400	2-1/4"	3-5/8"

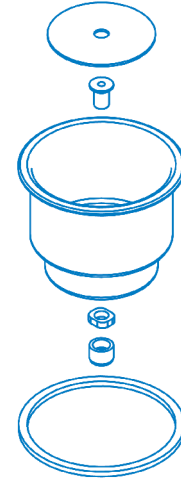

## DRINK CUP HOLDERS-Dual Stack

Part No.	Depth	Large Cup Width	Small Cup Width	Pad	Gasket	Drain
SSDC70000	3-17/64"	3-3/4"	2-7/8"	No	Yes	No
SSDC70100	3-17/64"	3-3/4"	2-7/8"	Yes	Yes	Yes
SSDC70200	3-17/64"	3-5/8"	2-7/8"	Yes	No	No
SSDC70300	3-17/64"	3-5/8"	2-7/8"	Yes	Yes	Yes
SSDC70500	3-17/64"	3-5/8"	2-7/8"	Yes	Yes	No
SSDC70600	3-17/64"	3-5/8"	2-7/8"	Yes	Yes	No
SSDC70700	3-17/64"	3-5/8"	2-7/8"	Yes	Yes	Yes



DECK  
HARDWARE

## RINGED CUP HOLDERS-Closed Sided

Part No.	No. of Cups	Material
SSDCRR-1	1	316 SS
SSDCRR-2	2	316SS
SSDCRR-3	3	316SS

## RINGED CUP HOLDERS-Opened Sided

Part No.	No. of Cups	Material
SSDCRRO-1	1	304 SS
SSDCRRO-2	2	304SS
SSDCRRO-3	3	304SS
SSDCRRO-4	4	304SS



# Grab Rails/Handles

Marine Hardware,™ Inc. manufactures an entire range of grab rails/handles and custom railings and handles. Materials include 304 stainless steel, 316 stainless steel, electro polished to machine polished to #7 finish. All rails/handles are available in round or oval and are even available with finger grips.

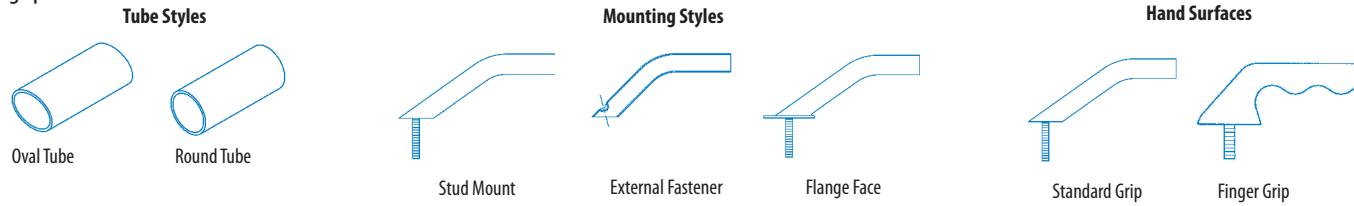

## GRAB HANDLES/RAILS - STUD MOUNT

Stainless steel, bright polished finish. All surface mounted grab handles come with welded washer in the inside of tubes. All studs parallel +/- 1/16".



Part No.	O.D. Tube	Tube Type	Length	Stud Distance (Center to Center)	Stud Size
SSGH10001	7/8"	Round	11-7/8"	10.20"	5/16" — 18x1-3/4"
SSGH10002	7/8"	Round	18"	16-1/8"	5/16" — 18x1-3/4"
SSGH10003	7/8"	Round	60"	3 Studs	5/16" — 18x2"
SSGH10008	7/8"	Round	9-3/8"	8-1/4"	5/16" — 18x1-5/8"
SSGR10003	7/8"	Round	11-3/8"	9-7/8"	5/16" — 18x2-3/16"
SSGR10004	7/8"	Round	19-3/8"	177/8"	5/16" — 18x2-5/16"
SSGR10005	3/4"x1"	Oval	20"	19"	5/16" — 18x2-1/8"
SSGR10007	3/4"x1"	Oval	24"	23"	5/16" — 18x2-1/8"
SSGR10013	7/8"	Round	14"	12"	5/16" — 18x1-3/4"

## GRAB RAILS - EXTERNAL FASTENERS

Marine Hardware,™ Inc. has many sizes in stock with outside countersunk holes for secure fastening.

Part No.	O.D. Tube	Tube Type	Length	Stamped Counter Sunk Holes	Fasteners
SSGR10001	7/8"	Round	18"	Yes	#10
SSGR10002	7/8"	Round	12"	Yes	#10
SSGR10001-OVL	7/8"x 1	Oval	18"	Yes	#10
SSGR10002-OVL	7/8"x 1	Oval	12"	Yes	#10



## GRAB HANDLE/RAILS - FLANGE FACES w/STUDS

Marine Hardware,™ Inc. has several sizes in stock plus custom sizes as needed. All two stud models have parallel studs +/- 1 degree.

Part No.	O.D. Tube	Tube Type	Length	Stud Distance (Center to Center)	Stud Size
SSGH10004	7/8"	Round	9-3/4"	8-1/4"	5/16" — 18x1-5/8"
SSGR10008	3/4"x1"	Oval	9-3/4"	8-1/4"	5/16" — 18x2-1/2"
SSGR10016	7/8"	Round	13-1/2"	12"	5/16" — 18x2-5/16"
SSGR10018	3/4"x1"	Oval	9-3/4"	8-1/4"	w/o studs

# Grab Rails/Handles

## GRAB RAIL - w/Base Covers

Marine Hardware,™ Inc. has several sizes in stock and comes with base covers.

Part No.	O.D. Tube	Tube Type	Length	Screw Holes in Base
SSGR10019	1-1/4"	Round	18"	3



## GRAB HANDLE - Stud Mount

The Marine Hardware,™ Inc.'s Grab Handle is the perfect choice for easy to install, one piece handles for interior applications. Burnished 304 stainless steel.



Part No.	O.D. Tube	Tube Type	Length	Stud Distance (Center to Center)	Stud Size
SSGH10007	3/4"x1-1/8"	Oval	9"	7-27/32"	5/16"—18x2-5/32"
SSGR10006	7/8"	Round	7-1/2"	6-5/8"	5/16"—18x2-1/2"
SSGR10009	3/4"x1"	Oval	12-1/8"	10-27/32"	5/16"—18x2.28"
SSGR10010	3/4"x1"	Oval	9-1/8"	8-1/8"	5/16"—18x2.30"
SSGR10011	7/8"	Round	8-7/8"	6-5/8"	5/16"—18x1.50"

## CABINET HANDLES

Marine Hardware,™ Inc.'s cabinet handles are CNC machined from precision 304 stainless steel and built in a kit form that allows the user to make up a variety of cabinet handles in lengths to fit an entire vessels needs. These parts simply screw together and when installed are locked into place. Standard finish is brushed stainless, bright polished and gold plating is available on request.

Part No.	O.D. Tube	Tube Type	Length	Stud Distance (Center to Center)	Material
SSGR10010	7/8"	Round	11"	7"	304 S.S.
SSDH10001	9/16"	Round	7"	5"	202 S.S.
SSDH10002	9/16"	Round	14-1/2"	12-5/8"	202 S.S.
SSDH10003	9/16"	Round	5-3/4"	3-3/4"	202 S.S.
SSDH10004	9/16"	Round	10-3/4"	8-13/16"	202 S.S.
SSDH10005	9/16"	Round	28-1/2"	26-1/2"	202 S.S.



## Fiddle Rails

### FIDDLE RAILS

Our unique modular design Fiddle Rail System is perfect for every interior application. Component constructed stand off's with rail lengths in a variety of sizes make this system very easy and elegant. Our system also includes optional gold plated accent cylinder bushings for added styling.

Part No.	Description
WSPT730056-1	5-1/2"x1/2" Rail
WSPT730056-11	20"x1/2" Rail
WSPT730056-3	36-1/2"x 1/2" Rail
WSPT730056-4	9"x 1/2" Rail
WSPT730056-8	18"x1/2" Rail
WSPT730056-18	Rail Fitting
WSPT730056-19	30-1/2"x 1/2" Rail

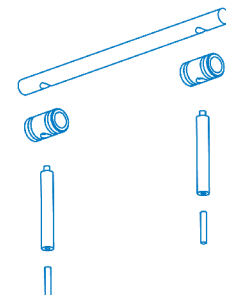
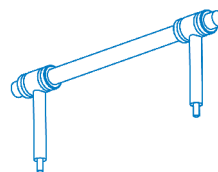

# Cast Rod Holders



30°



15°



0°

## ROD HOLDER - Cast Oval

A heavy duty cast stainless rod holder with an attractive oval flange that is style matched in 0°, 15° and 30° versions. Equipped to accept a hose barb to divert washdown water to the bilge or overboard, or standard open base.

Part No.	Angle	Int. Hole	Depth	Base Type
SSRH4500C-0	0°	1-5/8"	8"	Drain
SSRH4500C-15	15°	1-5/8"	8"	Drain
SSRH4500C-30	30°	1-5/8"	8"	Drain
SSRH4510C-0	0°	1-5/8"	8"	Open
SSRH4510C-15	15°	1-5/8"	8"	Open
SSRH4510C-30	30°	1-5/8"	8"	Open

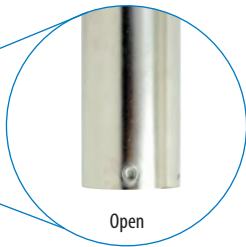

Open

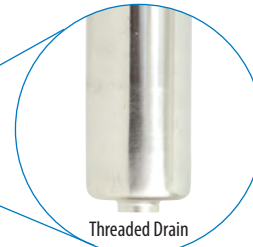

Threaded Drain

## ROD HOLDER - Cast Rectangle

This unique design features an investment cast 316 stainless steel flange with neck. The cast-in neck (30° angle) affords more strength and corrosion-resistance to the unit. The 304 stainless steel tube is welded to the neck. Unit comes with white PVC flanged insert liner to protect rod butt. Also includes mounting gasket to seal out water.

Part No.	Int. Hole	Depth	Base Type
SSRH4035-C	1-5/8"	8-5/8"	Open tube w/ cross pin
SSRH4035C-30	1-5/8"	1-5/8"	Cast-in drain for drain fitting

Contact our sales department to order custom rod holders with your logo cast-in.



# Stamped Rod Holders

## STAMPED ROD HOLDERS - Oval Head

Our stamped rod holders are made of 304 stainless steel in the standard 8-1/2" length. Includes a gasket to fit under the flange for a sealed installation. Available with your choice of liner inserts to protect the rod butt: a white PVC insert (no cap model), or a black neoprene insert with self attaching cap to seal out water and debris when the holder is not in use. An optional drain and self-attached plug for the bottom end of the tube is available in black neoprene or end cap with out drain.



Part No.	Angle	Int. Hole	Depth	Base Type	Gasket	Cap
SSRH4300-S	30°	1-5/8"	8"	Open	Yes	Yes
SSRH4300-S-GASKET	Replacement gasket only					
SSRH4310S-0	0°	1-5/8"	8"	Open	Yes	No
SSRH4310S-15	15°	1-5/8"	8"	Open	Yes	No
SSRH4310S-30	30°	1-5/8"	8"	Open	Yes	No

Replacement liners are available for each of the above.



## STAMPED ROD HOLDER - Trapezoid Head

Part No.	Angle	Int. Hole	Depth	Base Type
SSRH4307-S	30°	1-5/8"	8-5/8"	Open
SSRODINSERT-BK	Black replacement cap/insert			
SSRODINSERT-WT	White replacement cap/insert			



## STAMPED PLASTIC ROD HOLDERS - Two Piece

Injected molded base with stainless decorative deck face. This part can be used with or without stainless face.

Part No.	Angle	Int. Hole	Depth	Base Type
RODH10003	30°	1-5/8"	9"	Open
RODH10001	90°	1-3/8"	8"	Open
RODH10003-CAP	S.S. Replacement Face for RODH10003			
RODH10001-CAP	S.S. Replacement Face for RODH10001			

## ROD HOLDER END CAPS

Nitril rubber construction, fits all rod holders.

Part No.	Drain Type
SSRH-RUBRPLUGW/OD	Without Drain
SSRH-RUBRPLUG/DR	With Drain



# No Bolt Rod Holders

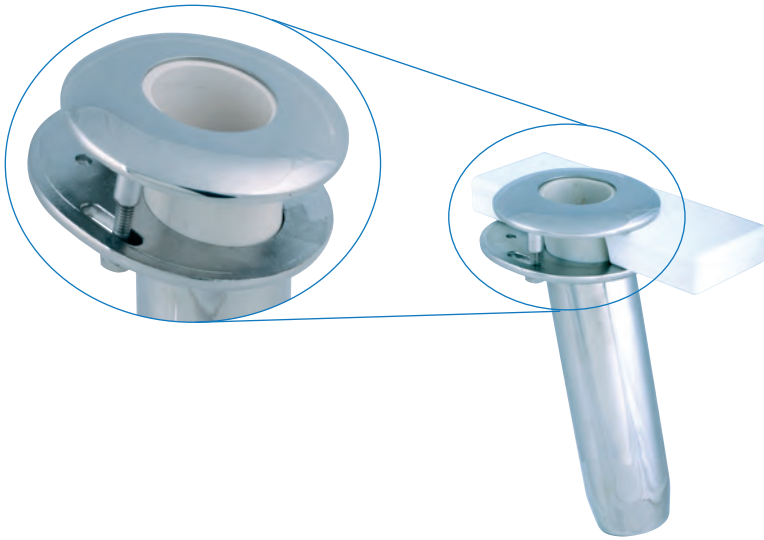

## ROD HOLDER - "No Bolt"

Features an investment cast 316 stainless steel body and flange with matching cap. The body and cap are electro-polished —lower section and top cap bright polished. Cast-in stop bar at the bottom, no bolt holes show above the rail. White plastic or rubber liners, drain fittings, and plugs are available. Custom logos can be cast or laser etched into the body or head. Under license from Release Marine.

Part No.	Angle	Below Rail Width	Depth	O.D. Flange
SSRHNB-15	15°	5-5/8"	7-1/4"	4"
SSRHNB-30	30°	8-1/8"	7-1/4"	4"
SSRHNB15DEG-CAP	Replacement head for SSRHNB-15			
SSRHNB30DEG-CAP	Replacement head for SSRHNB-30			
SSRHNB-LINER15DEG	Replacement liner for SSRHNB-15			
SSRHNB-LINER30DEG	Replacement liner for SSRHNB-30			

# Weldable Rail Bases-Stamped 316SS



## 60° STAMPED RECTANGLE BASE - Weldable

Part No.	Tube O.D.	Base	Fastener
SSWB77001-S	1"	3-3/4"x 2"	1/4"



## 90° STAMPED RECTANGLE BASES - Weldable

Part No.	Tube O.D.	Base	Fastener
SSWB77100-STMP	7/8"	3-3/16"x 1-3/4"	#10
SSWB77101-S	1"	3-3/4"x 2"	1/4"



## FLAT STAMPED RECTANGLE BASE - Weldable

Part No.	Base
SSWB77102-S	3-3/4"x 2"

# Weldable Rail Bases-Cast

Built out of heavy duty investment cast 316 stainless steel for consistent thickness and to prevent warping during welding. All are bright polished.

## 45° RECTANGLE BASES

Part No.	Tube O.D.	Base	Fastener
SSWB77500	7/8"	3"x 1-3/4"	#10
SSWB77501	1"	3"x 1-3/4"	1/4"



## 60° RECTANGLE BASES

Part No.	Tube O.D.	Base	Fastener
SSWB77000	7/8"	3-1/8"x 1-3/4"	#10
SSWB77001	1"	3-3/4"x 2"	1/4"



## 90° RECTANGLE BASES

Part No.	Tube O.D.	Base	Fastener
SSWB77100	7/8"	3-1/8"x 1-3/4"	#10
SSWB77101	1"	3-3/4"x 2"	1/4"



## 45° ROUND BASES

Part No.	Tube O.D.	Base Dia.	Fastener
SSWB77400	7/8"	2-11/16"	#10
SSWB77401	1"	2-11/16"	1/4"



## 60° ROUND BASES

Part No.	Tube O.D.	Base Dia.	Fastener
SSWB77200	7/8"	2-3/4"	#10
SSWB77201	1"	2-3/4"	1/4"



## 90° ROUND BASES

Part No.	Tube O.D.	Base Dia.	Fastener
SSWB77300	7/8"	2-3/4"	#10
SSWB77301	1"	2-3/4"	1/4"



# Rail Fittings



## 60° ROUND BASES

For intermediate support, starting or ending. Investment cast 316 stainless steel, bright polished. With 1/4" —28 set screw.

Part No.	Tube O.D.	Base Dia.	Fastener
SSFB66040	7/8"	2-1/2"	#10
SSFB66140	1"	2-3/4"	1/4"



## 90° ROUND BASES

For intermediate support, starting or ending. Investment cast 316 stainless steel, bright polished. With 1/4" —28 set screws.

Part No.	Tube O.D.	Base Dia.	Fastener
SSFB66039	7/8"	2-1/2"	#10
SSFB66139	1"	2-3/4"	1/4"



## 45° RECTANGLE BASES

For sleek angles at starting and ending. Investment cast 316 stainless steel, bright polished. With 1/4" —28 set screws.

Part No.	Tube O.D.	Base Dia.	Fastener
SSFB66015	7/8"	3"x1-3/4"	#10
SSFB66115	1"	3-1/4"x 1-7/8"	1/4"



## 60° RECTANGLE BASES

For intermediate support, starting or ending. Investment cast 316 stainless steel, bright polished. With 1/4" —28 set screws.

Part No.	Tube O.D.	Base Dia.	Fastener
SSFB66042	7/8"	3"x1-3/4"	#10
SSFB66142	1"	3-1/4"x 1-7/8"	1/4"



## 90° RECTANGLE BASES

For intermediate support, starting or ending. Investment cast 316 stainless steel, bright polished. With 1/4" —28 set screws.

Part No.	Tube O.D.	Size	Fastener
SSFB66041	7/8"	3-3/4" x 1-3/4"	#10
SSFB66141	1"	3-1/4" x 1-7/8"	1/4"

# Rail Fittings

## 90° TEES

Provide connections at intermediate support points. Investment cast 316 stainless steel, bright polished. Complete with 1/4" —28 cup point set screws.

Part No.	Tube O.D.
SSFT66043	7/8"
SSFT66143	1"



## 60° TEES

Provide connections at intermediate rail support points. Also useful where a steep rise in rail height is required. Designed for left or right. Investment cast 316 stainless steel, bright polished. Comes with 1/4" —28 cup point set screws.

Part No.	Tube O.D.	Use
SSFT66044	7/8"	Left
SSFT66045	7/8"	Right
SSFT66144	1"	Left
SSFT66145	1"	Right



## 60° UNIVERSAL TEES

Can be used for either left or right applications. Investment cast 316 stainless steel, bright polished. Comes with 1/4" —28 cup point set screws.

Part No.	Tube O.D.
SSFT66093	7/8"
SSFT66193	1"



## 30° ROUND BASES

For sleek angles at starting and ending. Investment cast 316 stainless steel, bright polished. Comes with 1/4" —28 cup point set screws.

Part No.	Tube O.D.	Base Dia.	Fastener
SSFB66077	7/8"	2-1/2"	#10
SSFB66177	1"	2-3/4"	1/4"



## 45° ROUND BASES

For sleek angles at starting and ending. Investment cast 316 stainless steel, bright polished. Comes with 1/4" —28 cup point set screws.

Part No.	Tube O.D.	Base Dia.	Fastener
SSFB66014	7/8"	2-1/2"	#10
SSFB66379	7/8"	2-1/2"	#12
SSFB66114	1"	2-3/4"	1/4"



# Top Fittings

## TOP CAPS



Investment cast 316 stainless steel. Bright polished. With 1/4" — 28 cup point set screw.

Part No.	Tube O.D.	Pin Size
SSTF66101	7/8"	1/4"
SSTF66103	1"	1/4"
SSTF66111	1-1/4"	1/4"

## PAD EYES

Fabricated 304 stainless steel.

Part No.	Length	Height	Width
SSTF-66105	1-7/8"	21/32"	1/2"
SSPE10001	2"	3/4"	3/8"



## TOP SLIDES with BOLT

Available in closed type and hinged type. Investment cast 316 stainless steel. Bright polished. Closed type has 1/4" — 28 cup point set screw.

Part No.	Tube O.D.	Type	Pin Size
SSTF66100	7/8"	Closed	1/4"-20
SSTF66102	1"	Closed	1/4"-20
SSTF66116	1-1/2"	Hinged	1/4"-20
SSTF66118	2"	Hinged	1/4"-20



## 90° DECK HINGE

Available with bolt or with removable pin. Investment cast 316 stainless steel. Machined base for flush fit. Bright polished.



Part No.	Type	Base Size	Fastener
SSTF66104	Bolt 1/4"-20	7/8"x 2"	#10
SSTF66220	Remov. Pin 1/4"	7/8"x 2"	#10

## DECK HINGE, ANGLED BASE

12° slant off vertical. With bolt. Investment cast 316 stainless steel. Machined base for flush fit. Bright polished.

Part No.	Base Size	Pin Size	Fastener
SSTF66222	7/8"x 2"	1/4"-20	#10



## DECK HINGE, RADIUS BASE

Concave mounting surface will universally mount either 7/8" or 1" O.D. tubing. Investment cast 316 stainless steel. Available with bolt or removable pin.



Part No.	Base Length	Type	Fastener
SSTF66104-RAD	2"	Remov. Pin 1/4"	#10
SSTB66105	2"	Bolt 1/4"-20	#10

## PULL PIN

Available in custom grip sizes and coated nylon with stainless steel tab optional.

Part No.	Pin Dia.	Pin Length	Lanyard Length
SSPP.25X1.25W/RG	1/4"	7/8"	N/A
SSPP.25X1.38W/RG	1/4"	1"	N/A



## PULL PIN

Fabricated 304 stainless steel.

Part No.	Pin Dia.	Pin Length	Lanyard Length
SSPP.25X1.00W/RG-L	1/4"	1"	6-1/2"



## PULL PIN w/ PLASTIC CAP

Fabricated 304 stainless steel.

Part No.	Pin Dia.	Pin Length	Lanyard Length
SSPP.19X1.50W/CAP-L	3/16"	1"	3-1/8"



## REMOVABLE PIN w/ TOGGLE

Fabricated 304 stainless steel. Available in custom lengths.

Part No.	Pin Dia.	Pin Length	Lanyard Length
SSPP.25X1.50	1/4"	1-3/16"	N/A



## PULL PIN - W/ TOGGLE

Fabricated 304 stainless steel.

Part No.	Pin Dia.	Pin Length	Lanyard Length
SSPP1.12X6.0	1/4"	1-1/4"	6"



## STAND OFF - With Base

Investment cast 316 stainless steel. Bases machined flat for stable mounting surface.

Part No.	Size
SSTF50001	5/8"



## STAND OFF - THREADED

Investment cast 316 stainless steel. Bases machined flat for stable mounting surface. Radiused surface can fit 7/8" and 1" O.D. tube.

Part No.	Size
SSTF50000	5/8"
SSTF50100	7/8"
SSTF50200	1"



## PELICAN HOOKS

Easy open gate latch with clean simple styling. Opens with one hand tug on the integral spring loaded plunger. Automatically latches when snapped closed. Includes swage terminal and locknut. Investment cast 316 stainless steel, bright polished. Right hand thread.

Part No.	For Wire Dia.
SSPH-PELICAN-.125	1/8"
SSPH-PELICAN-.188	3/16"

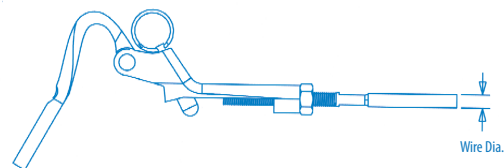

# Turnbuckle

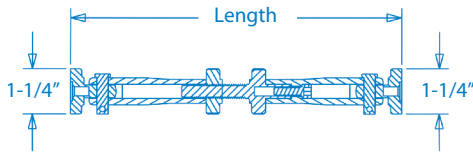

## TURNBUCKLE

Stainless steel thumb twist knob for simple adjustment in the water, no tools required. Investment cast 316 stainless steel for corrosion resistance and strength. CNC threads for smooth operation.

Part No.	Length
SSTB66000	8-1/2" to 9-1/2"

# Steps

## FOLDING STEPS

Cast 316 with fold up feature for stowing.

Part No.	Base	Step
SSTP10002	1-7/8" x 4-1/2"	2" x 3-3/8"
SSTP10003	2" x 4-5/8"	2-1/8" x 4-7/16"



## TRANSOM STEP

This large transom step is designed to meet new ABYC and ISO standards for boarding steps. It also provides a large hand hold. Investment cast 316 stainless steel.

Part No.	Length	Width
SSTS75000	5-7/8"	5-1/8"



# Gunnel Caps - Rub Rails

## GUNNEL CAPS

Our specialty is custom parts for your yachts, for example, gunnel caps. We can manufacture them from investment cast 316 stainless steel, or from aluminum extrusion with anodized or powder coated finish. Send us a piece of your extrusion and let us build you a sample.

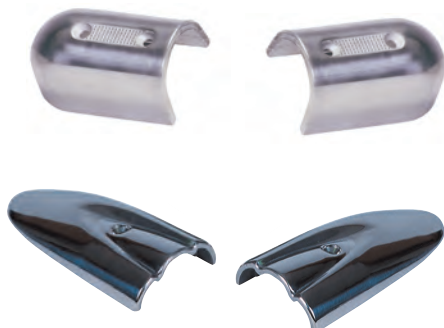

## HALF OVAL RUB RAILS

Fabricated 304 stainless steel, bright polished.

Part No.	Size
SSRR07501	3/4" x 12"
SSRR075X110.0	3/4" x 110"
SSRR075X113.38	3/4" x 113-3/8"
SSRR075X98.38	3/4" x 98-3/8"



# Bow Anchor Rollers

## BOW ANCHOR ROLLERS - Long Plate

Fabricated stainless steel in either 304 or 316. Custom shapes and sizes available.

Part No.	Overall Length	Length to Roller Center	Deck Mnt Length	Width	Roller Dia.
SSBR7558SN	18"	14-1/2"	12-3/4"	3-1/2"	3"
SSBR7557S1	15-3/8"	13"	12"	2"	2-1/2"



## BOW ANCHOR ROLLER

Fabricated from 304 stainless steel.

Part No.	Overall Length	Length to Roller Center	Roller Height	Width	Roller Dia.
SSBR7563SMH	5"	3-1/2"	3-1/8"	8-1/3"	4"



## CHAIN STOP

Three piece stainless steel chain stop assembly with removable pin.

Part No.	Base Length	Height
SSCS10001	3-1/8" x 2-3/4"	2-3/8"



# Anchor Chains & Swivels

## ANCHOR CHAIN

Hot dip galvanized, G4 ISO. Sold in keg quantities only.

Part No.	Size	Ft/Roll
CHN-HDGV0.250X150	1/4"	150'
CHN-HDGV0.312X150	5/16"	150'
CHN-HDGV0.375X200	3/8"	200'
CHN-HDGV0.375X300	3/8"	300'



## ARTICULATING ANCHOR SWIVELS

316 investment cast stainless steel body, electro-polished with bright polished exterior. Multi-directional 360 degree swivel, load tested to National Institute of Standards and Technology. Use Loctite 262 when installing.

Part No.	Overall Length	Shank Recess	Shank Bolt Dia.	Head Recess	WLL Lbs
SSAS00312A	4-5/8"	5/8"	3/8"	3/8"	3200
SSAS00500A	6-1/2"	3/4"	1/2"	9/16"	6600



## FIXED ANCHOR SWIVELS

316 investment cast stainless steel body, electro-polished with bright polished exterior.

Part No.	Overall Length	Shank Recess	Shank Bolt Dia.	Head Recess	WLL Lbs
SSAS00312F	3-5/8"	5/8"	3/8"	3/8"	3200
SSAS00500F	4-5/8"	3/4"	1/2"	9/16"	6600



# Ski Pylons



## SKI PYLONS

Marine Hardware,™ Inc., CNC turns a variety of custom ski pylons for all competition ski boats. Manufactured of 6061-T6 aluminum, polished finish is standard. Satin finish, powder-coated, or anodized finishes are optional. Custom lengths as well as swiveled top are available upon request.

Part No.	Dia.	Length
PYLN2.430-A	2-7/16"	39"
PYLN2.43-40-A	2-7/16"	40"
PYLN2.43-42-A	2-7/16"	42"
PYLN2.43-48-A	2-7/16"	48"
PYLN2.43-56-A	2-7/16"	56"

## PULL-UP SKI PYLON

This unique design pylon assembly is crafted for V-drive ski boats and small runabouts. In a retracted position the pylon is out of harms way. When in the extended position it becomes a durable heavy duty ski pylon or mooring cleat.

Part No.	Install Dia.	Extended Length	Installed Retracted Length
PULP1.500	2-1/4"	14"	17"

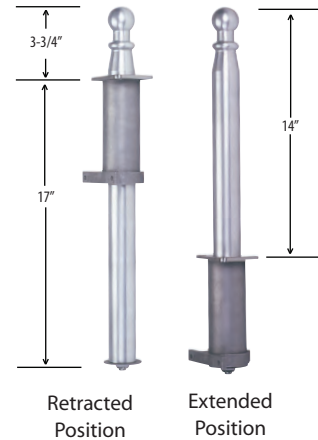

DECK  
HARDWARE



## RETRACTABLE SKI PYLON - Flush Mount

Bright polished for maximum corrosion protection. The flush oval measures 3-1/2" x 5-5/8" while the pylon measures 2-3/8" in diameter. All come with self drain for 3/8" tube.

Part No.	Extended Length	Retracted Length	Rating	Drain Style
SSRP10001	6-3/8"	11-1/4"	500 lbs	Straight
SSRP10002	4-5/8"	10-1/2"	1500 lbs	90°
SSRP10002L	6-3/8"	12"	1500 lbs	90°
SSRP10003	2"	11-1/4"	500 lbs	Straight
SSRP10004	1-1/4"	3-1/2"	500 lbs	None
SSRP10001-BRKT	Bracket and lower support bracket assembly			

## SKI TOW RINGS - Standard

Manufactured of 304 stainless steel for maximum strength and corrosion resistance. Studs oriented horizontally, complete with one strap washer (backing plate), two split style lockwashers, and two nuts, all of stainless steel.

Part No.	Ring Diameter	Stud Dia.	Stud Length
SSRI19006	2-1/2"	3/8"	2-1/2"
SSRI19010	3"	3/8"	4"
SSRI19011	3-1/2"	1/2"	4"



## SKI TOW RINGS - Vertical

Manufactured of 304 stainless steel for maximum strength and corrosion resistance. Studs oriented vertically, come complete with stainless steel washers and nuts.

Part No.	Ring Diameter	Stud Dia.	Stud Length
SSRI19007-V2.9	2-1/2"	3/8"	3"
SSRI19007-V3.3	2-1/2"	3/8"	3-3/8"

## CAST OVAL SKI TOWS

Our unique cast oval style ski tow is both functional and decorative. Cast 316 stainless steel, available with your logo or name.

Part No.	Ring Diameter	Stud Dia.	Stud Length	Logo Type
SSRI19008	4"x2-3/4"	3/8"	2-1/2"	Cast-in
SSRI19009	4"x2-7/8"	5/16"	2-1/2"	Drip mold



## SAMPSON POST

Cast 316 stainless steel. Bright polished.

Part No.	Height	Post	Crossbar Length
SSAMP10001	22"	4" square	10"

# Antenna Mounts



## ADJUSTABLE ANTENNA MOUNT

A heavy duty adjustable antenna mount that articulates for horizontal or vertical mounting surfaces. This mount is cast stainless steel and mirror polished. It is threaded for all standard 1" x 14 antennas and has a hole to allow the wire to pass through the threaded portion.

Part No.	Height	Base Dim.	Gasket	O-ring
SSAM-10000	6"	2-13/16"X3-3/4"	No	No
SSAM-10001	6"	2-13/16"X3-3/4"	Yes	Yes

## FIXED BASE ANTENNA MOUNTS

These sturdy antenna bases fit standard 1" – 14 threads common on standard VHF, GPS and TV antennas. The extensions have the same threads and are used for additional height or clearance on flybridges, T-top or radar arches. Antenna wire runs through the base. Extension poles for our antenna base are available. Will fit all others in the field.

Part No.	Description
SSAM-20000	1" - Pedestal Antenna Mount
SSAM-30000	4-1/8" - H/D Deck Antenna Mount



## ANTENNA EXTENSION POLES

Fabricated from 304 stainless steel tube, this easily extends the range of any antenna mount. Male threads on one end, female on the other. All three parts have a 1" O.D. Smooth exterior finish for a seamless look.

Part No.	Description
SSAM-40000	12" - Antenna Mount Extension
SSAM30009	9" - Antenna Mount Extension
SSAM30006	6" - Antenna Mount Extension

# TV Bracket

## FLAT SCREEN TV BRACKET

Cast and fabricated from 316 stainless steel, this removable bracket fits all flat panel monitors and allows for easy storage. This unit incorporates an indexable pin to securely hold the unit in any position and prevents unwanted rotation while boat is in operation. The standard unit stands 9" tall and other heights are available.

Part No.	TV Mnt. Dimensions	Post Height	Base Mnt Hole
MNTBRKT10001	3-1/2"x 3-1/2" to 4"x4"	9"	1-9/16"



# Vent Grills

## CUSTOM VENT GRILLS

Marine Hardware,™ Inc. manufactures an entire range of vent grills from cast 316 stainless steel, fabricated 304 stainless steel, injection molded plastic and any combination of material you can imagine. Send us your drawing or sketch for quotation and lead times.

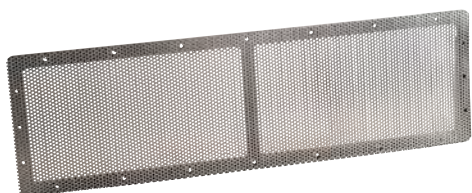

## REFRIGERATOR VENT

Stainless steel 304 bright polished surface and stainless steel 304 net.

Part No.	Length	Width
SSVN10002	7-5/16"	1-1/2"



## HOSE VENT

Stainless steel 304

Part No.	Flange	Hose OD
SSVN10003	4"x 4"	3"



## VENT GRILLS

This classy grill has a cast stainless body and stainless screen. Both are mirror polished and make a statement of quality installed on your boat.

Part No.	Width	Height	Thickness less studs
SSBC90210	6-1/8"	4-1/16"	5/8"
SSBC90310	9-3/16"	6-3/32"	7/8"



# Speaker Covers



## SPEAKER COVERS - STAINLESS STEEL

Part No.	Description
GRILL-SPKR1050SS-KIT	Grill kit for 10-1/2" speaker; Frames, Screen & 4 Screws
GRILL-SPKR602SS-KIT	Grill kit for 6" speaker; Frame, Screen & 4 Screws

# Custom Designed Parts

## CUSTOM DESIGNED PARTS

Your designers' dreams can become reality. Finally available to the marine industry, Marine Hardware,™ Inc. offers sophisticated computer modeling, parametric design, and a seamless link to computer-aided manufacturing to bring your most innovative concepts to life. Marine Hardware,™ Inc. takes pride in custom-manufactured specialty components for all vessels. Whether your needs are stainless steel, bronze, or aluminum, we specialize in quick turnaround of tooling for rapid prototypes and first article approval parts to meet your most demanding schedules.



# Access Hardware

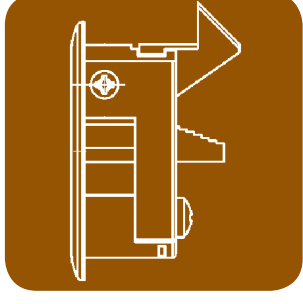
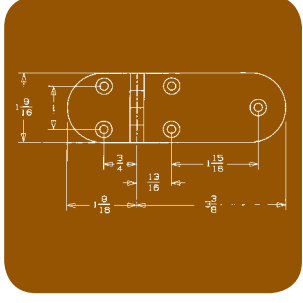
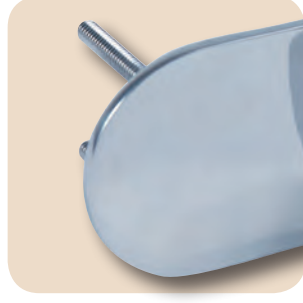
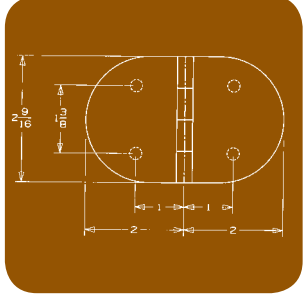
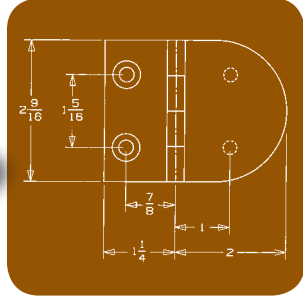
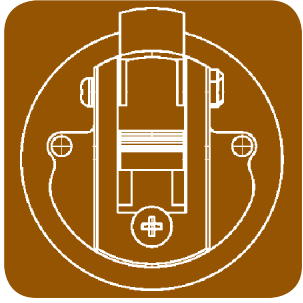

# Latches

Made of investment cast 316, electro-polished stainless steel, this latch incorporates a water resistant design and quality materials for smooth operation day after day. A pin cylinder is used in the locking version and a long pawl version is available for thicker mounting surfaces. Backing plates and mounting hardware are included. Application spacers are available.



Standard Pawl



Long Pawl



Locking Style

Part No.	Cutout Size	Lock	Key Code	Fasteners	Strike Plate	Packing Plate	Pawl	Gasket/Spacer
SSHN77004-1	2"	Yes	#1	#10-32x0.75	Yes	Yes	Std, 0.54"	No
SSHN77005-2	2"	Yes	#2	#10-32x0.75	Yes	Yes	Std, 0.54"	No
SSHN77006-3	2"	Yes	#3	#10-32x0.75	Yes	Yes	Std, 0.54"	No
SSHN77007-4	2"	Yes	#4	#10-32x0.75	Yes	Yes	Std, 0.54"	No
SSHN77004-4N	2"	Yes	#4	#10-32x0.75	Yes	Yes	Std, 0.54"	No
SSHN77005	2-1/8"	No	No	#10-32x0.75	Yes	Yes	Long, 0.54"	No
SSHN77008	2"	No	No	#10-32x0.38	Yes	Yes	Std, 0.54"	Blk form Gasket
—	—	—	—	#10-32x0.75	—	—	—	—
SSHN77009	2"	No	No	#10-32x0.75	Yes	Yes	Std, 0.54"	No
SSHN77011	2"	No	No	#10-32x0.50	Yes	Yes	Std, 0.54"	No
SSHN77013	2"	No	No	#10-32x0.50	Yes	Yes	Ext. Hght	Blk PVC Spcr 15/16"
SSHN77014	2"	No	No	#10-32x0.50	Yes	Yes	Std, 0.54"	Blk PVC Spcr 1/4"

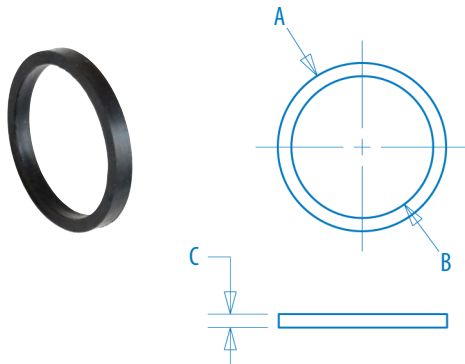

## SPACERS

Part No.	A	B	C
0095NRS2.36x2.00x0.093	2-23/64"	2"	3/32"
0095NRS2.36x2.00x0.188	2-23/64"	2"	3/16"
0095NRS2.36x2.00x0.250	2-23/64"	2"	1/4"

## SLAM LATCH - Rectangle Flush Mount

Cast in stainless steel and electro-polished. This latch is suited for medium size hatches and transom doors. Custom details for gasket spacers, strike plates, & logos optional. Three 1/4" holes for fasteners.

Part No.	Strike Plate	Cutout Size	Lock	Pawl Grip	Type
SSHN77010	Custom	3"x 3-7/16"	No	3/4"	Standard
SSHN77012	Custom	3"x 3-7/16"	No	3/4"	Waterproof



# Latches

## BARREL LATCHES w/ SLIDER

Two sizes available, investment cast 316, firmly latches in either opened or closed position.

Part No.	Length	Width
SSLA10002	5-1/4"	1-1/2"
SSLA10003	3-1/2"	1-1/2"



## TRANSOM DOOR LATCH

Stainless steel 316 casting, bright polished.

Part No.
SSDL10001

## CABINET LATCH

Our unique cabinet latch operates as a pull knob when unlocked and detents flush when locked. Simple round design makes for easy installation. Available in a variety of finishes from chrome to brass.

Part No.
SSLA10005-CAB



## FLUSH DECK TIE-DOWN

Investment cast 316 stainless steel, removable loop fastener for flush fit.

Part No.
SSTD67737

## SPRING HATCH OPENING

Stainless steel with wire spring. Available in any length.

Part No.	Length
SSBK10003	8-1/4"



# Lift Rings & Pulls



## RECESSED LIFT RING - Small

Investment cast 316 stainless steel. Bright polished. Ring is flush to plate. For use on small cupboards and hatches.

Part No.	Size	Fastener
SSRI66022	1-1/2" X 1-7/8"	#8



## RECESSED LIFT RING - Large

Investment cast 316 stainless steel, bright polished. Ring is flush to plate.

Part No.	Size	Fastener
SSRI26700	2-5/16" X 2-1/2"	#8



## HATCH PULLS

Fabricated stainless steel, with gasket.

Part No.	Description	Stem Length
SSHP80002	Single Stem	2"
SSHP80003	Single Stem	3"

# Door Stops

## MAGNETIC DOOR CATCH - Short

Small oval base with pivoting magnetic holder.

Part No.	Stop Length
SSMC10001	2"



## DOOR STOP AND HOLDER

Door stop has a spring loaded catch that holds the door when fully open. A rubber cushion protects the door's finish. The holder is cast in stainless steel with a stamped keeper.

Part No.	Stop Length
SSDS90000-W	2-1/2"
SSDS90010-W	3-3/4"
SSDS90020-W	4"

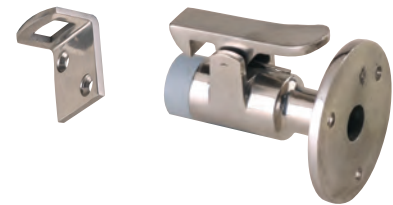

## MAGNETIC DOOR CATCH - Flush

Extended or small oval base with pivoting magnetic holder to fit flush on application.

Part No.	Stop Length	Size
SSMC10003	3-1/2"	Extended
SSMC10002	1-1/4"	Small



SSMC10002

SSMC10003

# Cast Hinges

## STOCK AND CUSTOM HINGES

Marine Hardware, <sup>TM</sup> Inc. specializes in supplying thousands of hinges from stock to custom designed. Manufactured from a variety of materials from 1204/1216 cast or fabricated to injected molded plastics to fit your specialized needs. We stock many styles to suit your needs from butt hinges, offset, take-a-part, seat hinges, scissor or piano hinges, we probably have a stock hinge for what you need.

### DOOR HINGES - EQUAL SIDES

Stainless steel 316 cast hinge, bright polished.

Part No.	A	B	C	D	Fastener
SSHN66028	3"	1-1/2"	1-1/2"	1-1/2"	#8
SSHN66029	4"	1-1/2"	2"	2"	#10

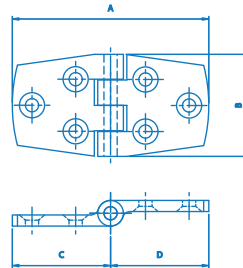

### DOOR HINGES-UNEQUAL SIDES

Stainless steel 316 cast hinge, bright polished.

Part No.	A	B	C	D	Fastener
SSHN66007	2-1/4"	1-1/2"	1-1/2"	3/4"	#10
SSHN66021	2-3/4"	1-1/2"	2-1/8"	3/4"	#10

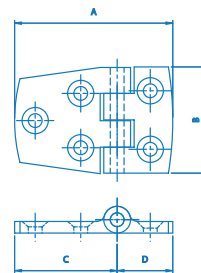

### DOOR HINGES

Stainless steel 316 cast hinge, bright polished.

Part No.	A	B	C	D	Fastener
SSHN66009	3-5/8"	2-1/8"	1-1/2"	3/4"	#10

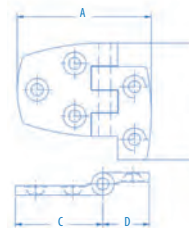

### TAKE-APART HINGE

Stainless steel 316 cast hinge, bright polished.

Part No.	A	B	C	D	Fastener
SSHN66024	3-5/8"	2-1/8"	1-13/16"	1-13/16"	#10

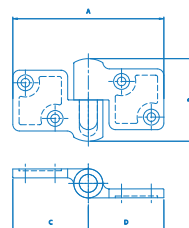

### UPHOLSTERY HINGE

Stainless steel 316 cast hinge, bright polished.

Part No.	A	B	C	D	Fastener
SSHN66500	2-1/2"	3-1/4"	2-1/4"	2"	#1/4-20

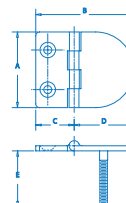

### FLUSH MOUNT HINGES

Stainless steel 316 cast hinge, bright polished.

Part No.	A	B	C	D	Fastener
SSHN66501	2-1/2"	4"	2"	2"	4x1/4"-20
SSHN66503	2-9/16"	5-5/8"	2-1/4"	3-3/8"	4x1/4"-20

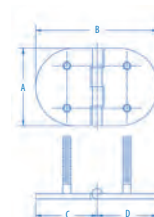

# Cast Hinges

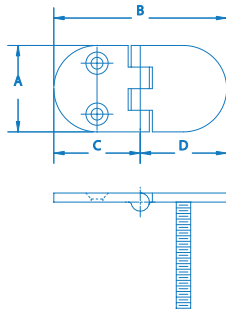

## UPHOLSTERY HINGE

Stainless steel 316 cast hinge, bright polished.

Part No.	A	B	C	D	Fastener
SSHN66502	1-1/2"	3"	1-1/2"	1-1/2"	#10 2x1/4" -20

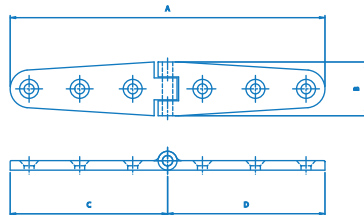

## STRAP HINGE-THREE HOLES PER SIDE

Stainless steel 316 cast hinge, bright polished.

Part No.	A	B	C	D	Fastener
SSHN66026	6"	1"	3"	3"	#10x3/side



SSHN66205  
SSHN66025

SSHN66206

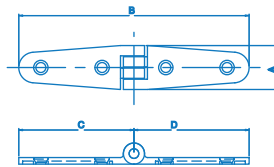

## STRAP HINGES-TWO HOLES PER SIDE

Stainless steel 316 cast hinge, bright polished.

Part No.	A	B	C	D	Fastener
SSHN66206	4"	1"	2"	2"	#10x2 side
SSHN66025	4"	1"	2"	2"	#10x2 side
SSHN66205	6"	1-1/4"	3"	3"	#10x2 side

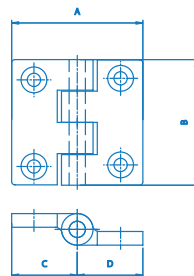

## BUTT HINGES

Stainless steel 316 cast hinge, bright polished.

Part No.	A	B	C	D	Fastener
SSHN66163	1-1/2"	1-1/2"	3/4"	3/4"	#10
SSHN66164	2"	2"	1"	1"	#10

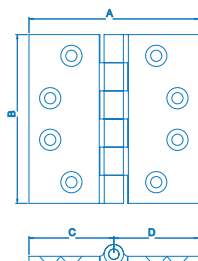

## BUTT HINGE

Stainless steel 316 cast hinge, bright polished.

Part No.	A	B	C	D	Fastener
SSHN66165	4"	4"	2"	2"	#1/4x8

# Cast Hinges

## BUTT HINGE

Stainless steel 316 cast hinge, bright polished. Sold in pairs.

Part No.	A	B	C	D	Fastener
SSHN66023	3"	3"	1-1/2"	1-1/2"	#1/4x6

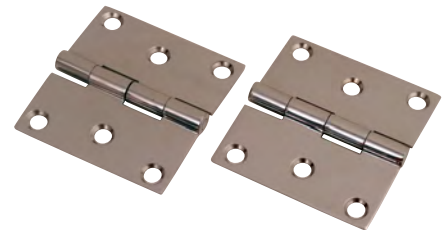
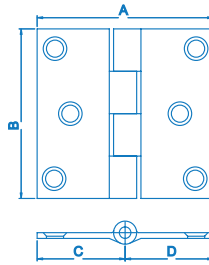

## BUTT HINGE

Stainless steel 316 cast hinge, bright polished.

Part No.	A	B	C	D	Fastener
SSHN66169	3"	4"	1-1/2"	1-1/2"	#1/4x6

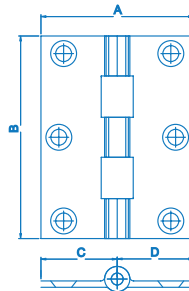

## BUTT HINGE

Stainless steel 316 cast hinge, bright polished.

Part No.	A	B	C	D	Fastener
SSHN66168	4"	4"	2"	2"	#1/4x6

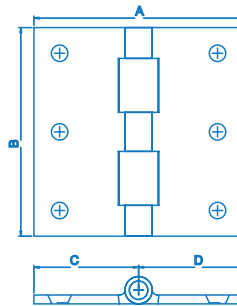

## ROUND HINGE

Stainless steel 316 cast hinge, bright polished.

Part No.	A	B	C	D	Fastener
SSHN66042	2-1/2"	2-1/2"	1-1/4"	1-1/4"	#1/4x4

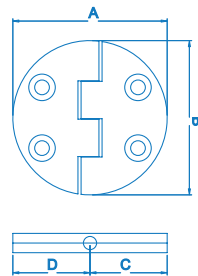

## UPHOLSTERY HINGE

Stainless steel 316 cast hinge, bright polished.

Part No.	A	B	C	D	Fastener
SSHN66504	2-1/2"	4"	2"	2"	#10
SSHN66506	2-1/2"	4"	2"	2"	#10

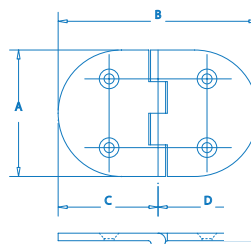

SSHN66504

SSHN66506

# Cast Hinges

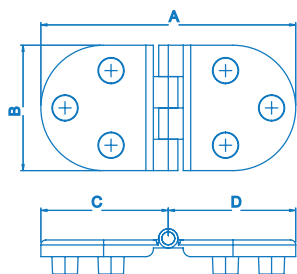

## FLUSH MOUNT HINGE

Stainless steel 316 cast hinge, bright polished.

Part No.	A	B	C	D	Fastener
SSHN66020	4"	2"	2"	2"	#1/4x6

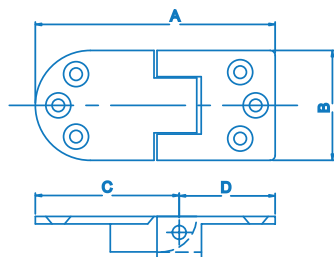

## FLUSH HINGE

Stainless steel 316 cast hinge, bright polished.

Part No.	A	B	C	D	Fastener
SSHN66300	3-3/4"	1-3/4"	1-7/8"	1-7/8"	#10

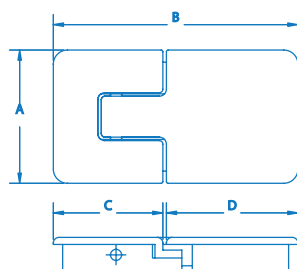

## FLUSH MOUNT HINGE

Stainless steel 316 cast hinge, bright polished.

Part No.	A	B	C	D	Fastener
SSHN66600	2-3/8"	4.-3/8"	2"	2-3/8"	Flush Mnt

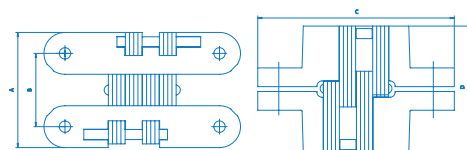
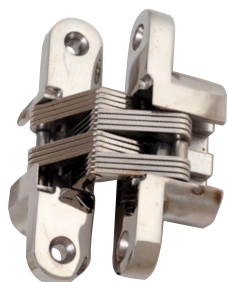

## SCISSOR HINGES

Stainless steel 316 cast hinge, bright polished.

Part No.	A	B	C	D	Fastener
SSHN55003	4-5/8"	2-23/32"	2-9/16"	9/16"	—
SSHN55005	1-3/8"	2-3/32"	1-1/4"	7/8"	—

# Stamped Hinges

## BUTT HINGES

Stainless steel 304 stamped hinge, bright polished.

Part No.	A	B	C	D	Fastener
SSHN66019	1-1/2"	2"	3/4"	3/4"	#10
SSHN66022	2"	2"	1"	1"	#10

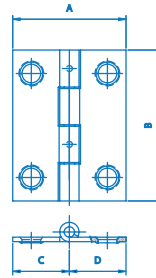

## UPHOLSTERY HINGE

Stainless steel 304 stamped hinge, bright polished.

Part No.	A	B	C	D	Fastener
SSHN66167	1-1/2"	1-1/2"	3/4"	3/4"	#10

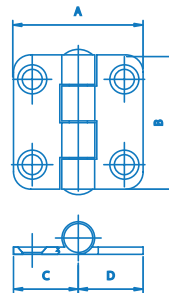

## UPHOLSTERY HINGE

Stainless steel 304 stamped hinge, bright polished.

Part No.	A	B	C	D	Fastener
SSHN66040	3"	3"	1-1/2"	1-1/2"	#10

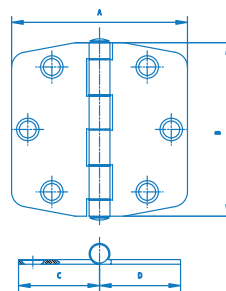

## DECK HINGES

Stainless steel 304 stamped hinge, bright polished.

Part No.	A	B	C	D	Fastener
SSHN66032	3"	1-5/8"	1-1/2"	1-1/2"	#8
SSHN66033	3"	1-5/8"	1-1/2"	1-1/2"	#8

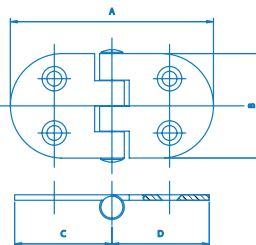

## DECK HINGE

Stainless steel 304 stamped hinge, bright polished.

Part No.	A	B	C	D	Fastener
SSHN660170	1-7/8"	1-1/8"	15/16"	15/16"	#6

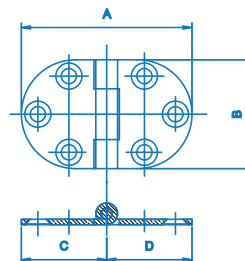

# Stamped Hinges

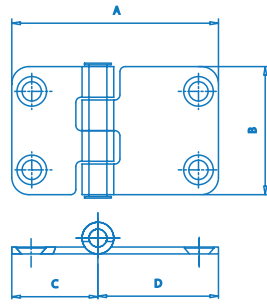

## UPHOLSTERY HINGE

Stainless steel 304 stamped hinge, bright polished.

Part No.	A	B	C	D	Fastener
SSHN66006	2-5/16"	1-1/2"	1"	1-5/16"	#8

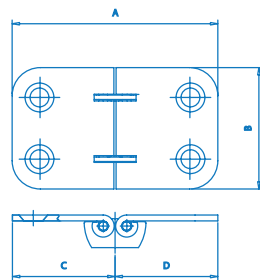

## UPHOLSTERY HINGE

Stainless steel 304 stamped hinge, bright polished.

Part No.	A	B	C	D	Fastener
SSHN66039	2-3/4"	1-5/8"	1-3/8"	1-3/8"	#8

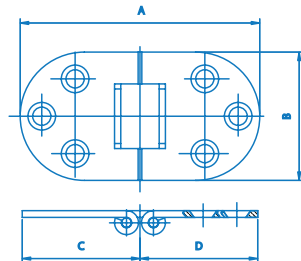

## UPHOLSTERY HINGE

Stainless steel 304 stamped hinge, bright polished.

Part No.	A	B	C	D	Fastener
SSHN67000	2-13/16"	1-1/2"	1-13/32"	1-13/32"	#8

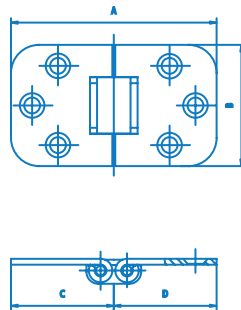

## UPHOLSTERY HINGE

Stainless steel 304 stamped hinge, bright polished.

Part No.	A	B	C	D	Fastener
SSHN67001	2-3/4"	1-5/8"	1-3/8"	1-3/8"	#8

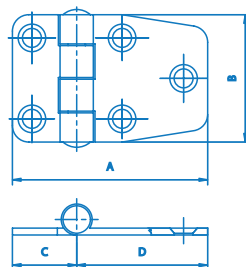

## UPHOLSTERY HINGE

Stainless steel 304 stamped hinge, bright polished.

Part No.	A	B	C	D	Fastener
SSHN66008	2-1/4"	1-1/2"	3/4"	1-1/2"	#8

# Stamped Hinges

## UPHOLSTERY HINGE

Stainless steel 304 stamped hinge, bright polished.

Part No.	A	B	C	D	Fastener
SSHN66030	3"	1-1/2"	1-1/2"	1-1/2"	#8

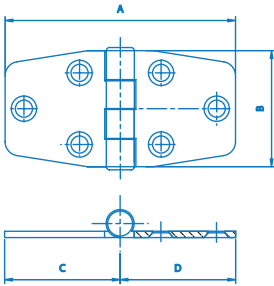

## UPHOLSTERY HINGE

Stainless steel 304 stamped hinge, bright polished.

Part No.	A	B	C	D	Fastener
SSHN66031	6"	3"	3"	3"	#1/4

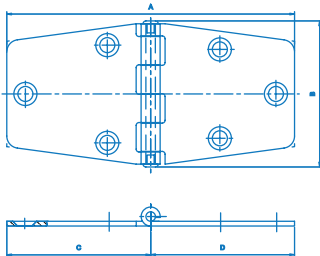

## UPHOLSTERY HINGE

Stainless steel 304 stamped hinge, electro-polished.

Part No.	A	B	C	D	Fastener
SSHN66034	5-5/8"	4"	1-5/8"	4"	#1/4

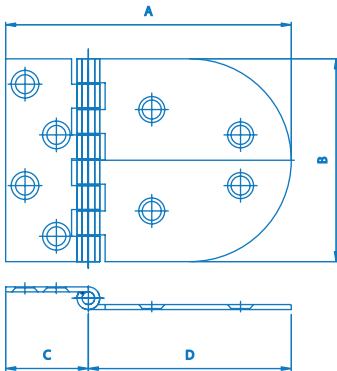

## UPHOLSTERY HINGE

Stainless steel 304 stamped hinge, electro-polished.

Part No.	A	B	C	D	Fastener
SSHN66037	6-5/8"	6"	3"	3-5/8"	#1/4

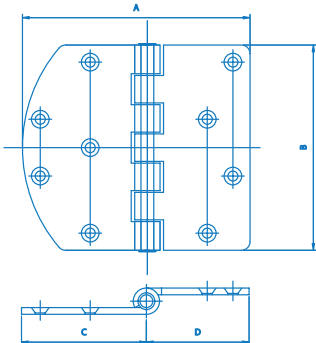

# Hinges



## HINGES

Stainless steel 304 stamped hinge, bright polished.

Part No.	Width	Length	Height
SSHNG6035	1-13/16"	5"	5/8"
SSHNG6036	3-5/8"	7"	3/4"



## PIANO HINGES- Parallel Holes

Stainless steel 304 stamped, electro polished.

Part No.	Width	Length	# Holes
SSHNP1A101	1-1/8"	9-7/8"	10
SSHNP1A201	1-1/4"	11"	10
SSHNP1A202	1-1/4"	12-1/2"	14
SSHNP1A203	1-1/4"	15-1/2"	16
SSHNP1A204	1-1/4"	23-1/2"	24
SSHNP1A205	1-1/4"	30-1/2"	30



## PIANO HINGES- Staggered Holes

Stainless steel 304 stamped electro polished.

Part No.	Width	Length	# Holes
SSHNP1A301	1-3/8"	10"	10

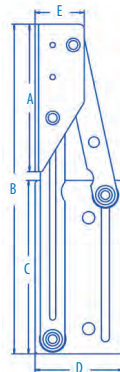

## SEAT HINGES

Stainless steel 304 fabricated, beautiful polish and stronger.

Part No.	A	B	C	D	E
SSHNG6041	2"	7-1/2"	4"	3-11/32"	1-1/8"

# Seat Hinges

## SEAT HINGES

Fabricated aluminum, white powder coated finish.

Part No.	A	B	C
ALUMHN10001	3-1/4"	7-1/4"	2-1/2"

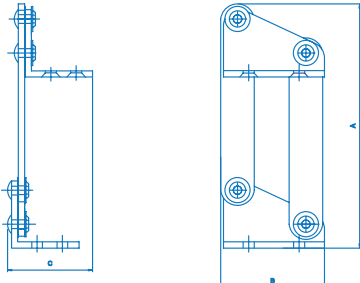

## SEAT HINGES

Fabricated aluminum, white powder coated finish.

Part No.	A	B	C
ALUMHN10005	3"	7-1/4"	2-3/8"

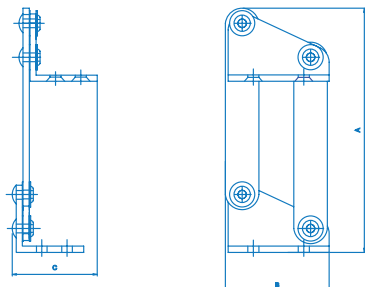

## SEAT HINGES

Fabricated aluminum, powder coated finish.

Part No.	A	B	C
ALUMHN10002	9-7/8"	7-3/4"	75.9°

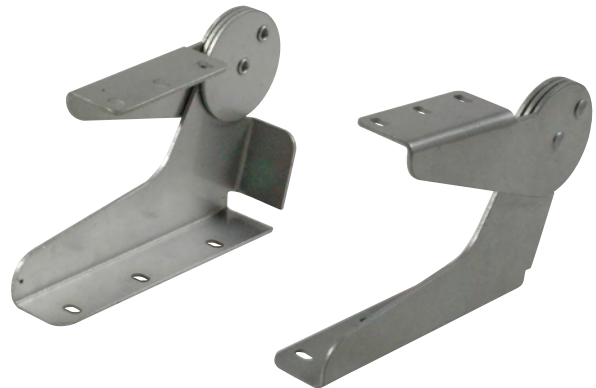
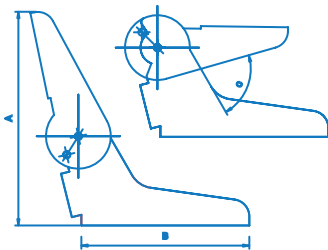

# Custom Hinges

Marine Hardware, <sup>TM</sup> Inc. specializes in supplying thousands of hinges from stock to custom designed. Manufactured from a variety of materials from 1204/1216 cast or fabricated to injected molded plastics to fit your specialized requirements. We stock many styles to suit your specification —from butt hinges, offset, take-apart, seat hinges, scissor or piano hinges, we probably have a stock hinge for what you need.



# Ladders

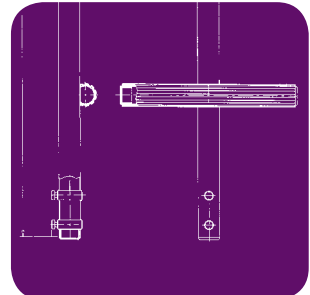
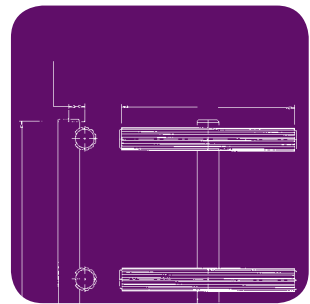
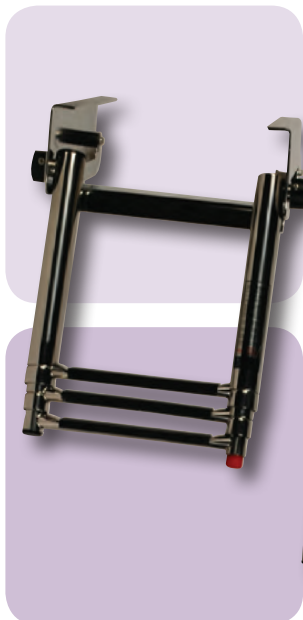
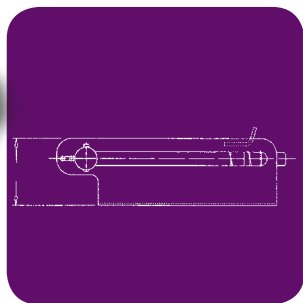
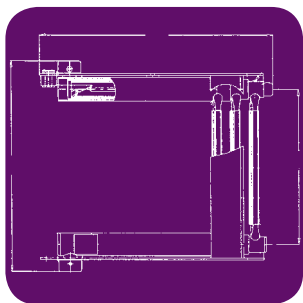
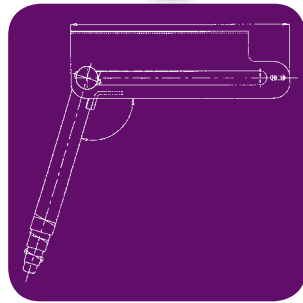
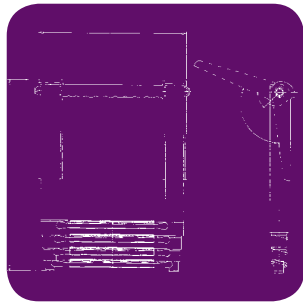

# Ladders

## UNDER SWIM PLATFORM LADDER

Fabricated 304 stainless steel, electro-polished with bright polished top surfaces. Button-activated deployment and is retractable for convenient storage. Optional hand grip available.

Part No.	Grab Rail	# of Steps	Length Deployed	Length Stowed (A)	Overall Width (B)	Height Stowed (C)
LADR30004	No	3	34-3/4"	15-1/2"	13-1/2"	5-1/8"

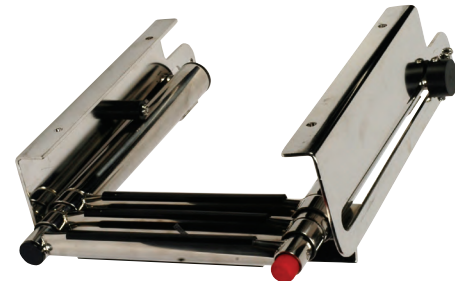

Optional hand grip available



Button-activated deploy



Sliding deployment

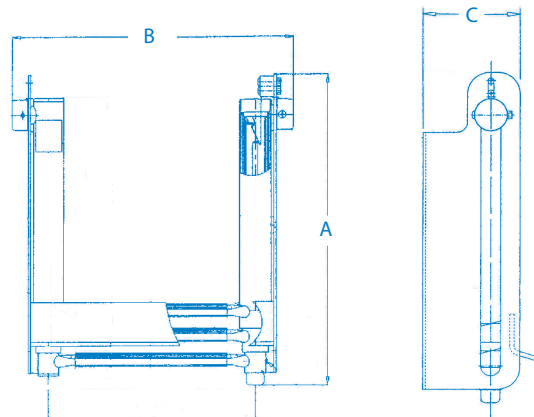
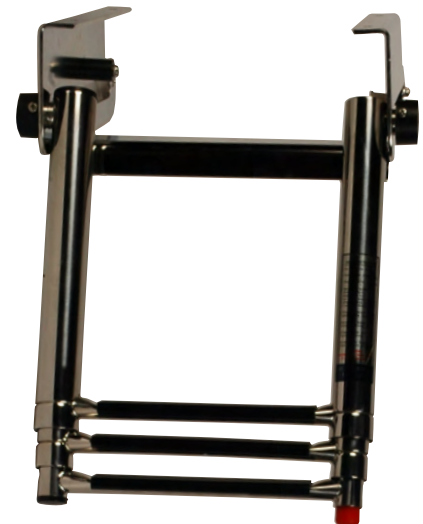

# Ladders

## TELESCOPING DECK LADDERS

Bright polished 304 stainless steel for maximum corrosion protection. Available in 2, 3, or 4-step models. Multiple options for mounting brackets available.



Optional Grip



*Note-* Sliding top mount bracket available for compact storage.

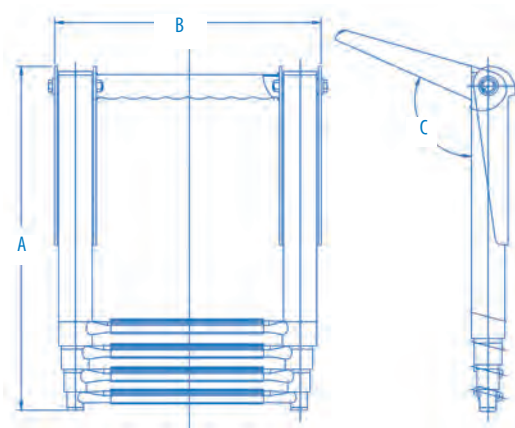
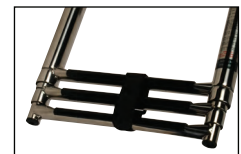

Part No.	Grab Rail	# of Steps	Length Deployed	Length Stowed (A)	Height Stowed	Overall Width (B)	Angle (C)	Mounting Bracket
LADR20002	YES	2	22-3/8"	13-1/4"	1-1/2"	11-3/4"	100	Fixed
LADR30001	YES	3	34-5/8"	14-3/4"	1-1/2"	12"	102	Fixed
LADR30003	NO	3	34"	14-5/8"	1-1/2"	12"	100	Fixed
LADR30005	NO	3	34-3/4"	14-1/2"	1-3/4"	11-3/8"	105.6	Sliding
LADR40001	NO	4	46"	16"	1-1/4"	12-1/2"	104	Fixed
LADR40002	YES	4	46"	15-1/2"	2"	12-1/2"	114	Fixed

# Dive Ladder

## DIVE LADDER—Floating

Fabricated 304 stainless steel and machine polished for maximum corrosion protection. Easy storage with plastic mounts. Breakaway design and designed to float.

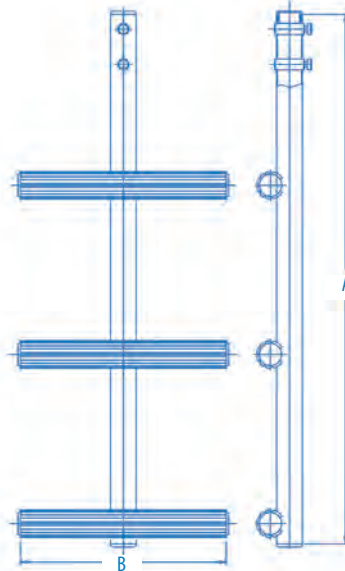

Part No.	# of Steps	Height (A)	Step Width (B)	# of Clips Included
LADR31001	3	36"	14"	2
LADR31001-BRKT	Stainless Steel Bracket with Backing Plate			
LADR31001-CLIP	Black Plastic Storage Clips (2pcs/set)			
LADR31001-KIT	LADR31001 + LADR31001-BRKT (Complete Set)			
LADR31001-BRKT2	Stainless Steel Bracket			
LADR31001-KIT2	LADR31001+LADR31001-BRKT2 (Complete Set)			



BRKT2

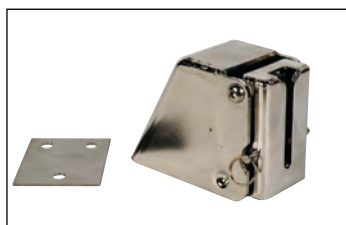

BRKT



STORAGE CLIPS

# Steering Wheels

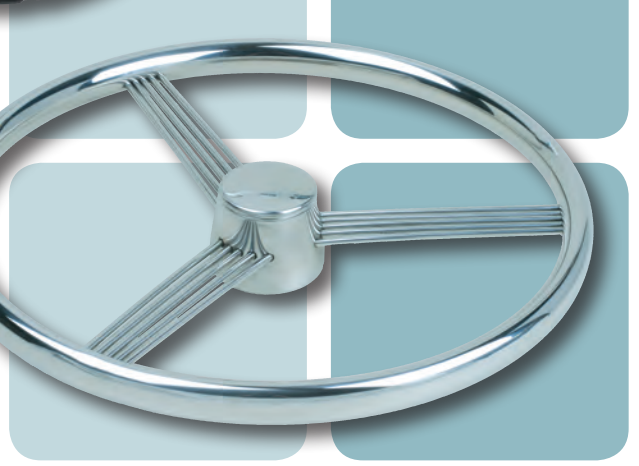
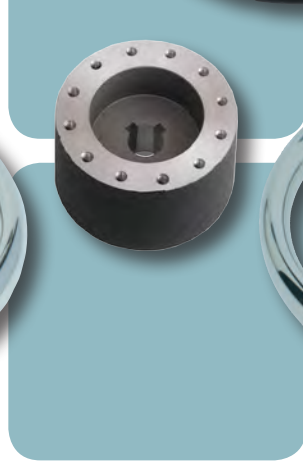
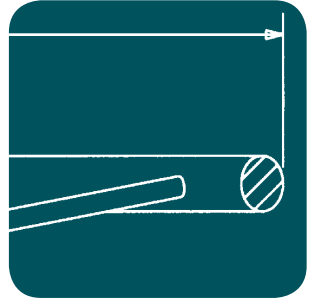
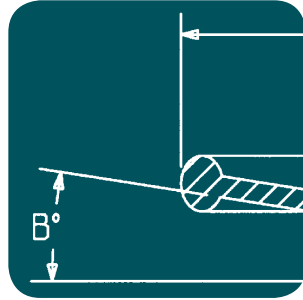
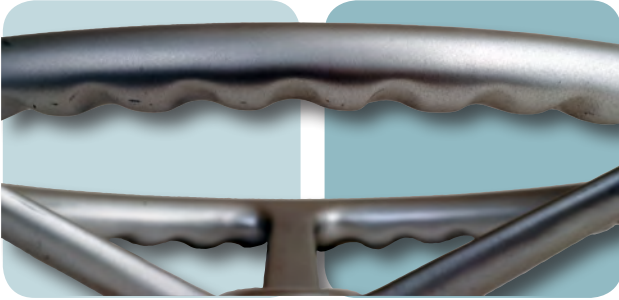

# Stainless Steel Steering Wheels

Marine Hardware,™ Inc. takes pride in manufacturing many styles of steering wheels. All are precision machined and keyed to fit standard 3/4" taper. All stainless wheels are fabricated from 304 tubing with an oval hand grip which is welded to an investment cast 316 hub. Hub caps are included on all sizes. Please specify diameter and dish angle.

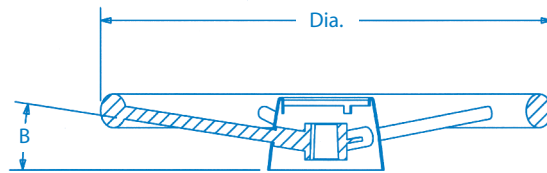

## DESTROYER - Stainless Steel

Fabricated from 304 tubing on a 316 hub. Brightly polished oval hand grip for comfort. Unit includes black cap.

Part No.	Diameter	Dish (B)
SSSW-13.00 X 2.38	13"	10°
SSSW-13.00 X 3.75	13"	25°
SSSW-15.50 X 2.75	15-1/2"	10°
SSSW-15.50 X 4.00	15-1/2"	25°
SSSW-18.00 X 10DEG	18"	10°
SSSW-20.00 X 10DEG	20"	10°
SSWBLACK-CAP	Replacement Cap	



## FABRICATED HUB & SPOKE

304 stainless steel, three spoke steering wheel. Comes with knob and cap. Custom laser logo or boat name available, please call for more information.

Part No.	Diameter	Dish (B)	Knob
SSSW13.50-1	13-1/2"	10°	Yes
SSSW13.50-1-CAP	S.S. Replacement Cap		



## HEAVY DUTY HUB & SPOKE

Heavy duty cast 304 stainless steel, three spoke steering wheel. Comes with knob, knob cap and wheel cap.

Part No.	Diameter	Dish (B)	Knob
SSSW13.50-2	13-1/2"	10°	Yes
SSSW13.50-2-NK	13-1/2"	10°	NO
SSSW15.50-2	15-1/2"	10°	Yes
SSSW15.50-2-NK	15-1/2"	10°	No

## HEAVY DUTY NUTS

Part No.	Thread	Nut Application
SSSWNUT0.500-20	1/2"-20	SSSW13.50-2 SSW13.50-2-NK
SSSWNUT0.625-18	5/8"-18	SSSW15.50-2 SSW15.50-2-NK



# Stainless Steel Steering Wheels

## BANJO STYLE - Stainless Steel

Custom laser logo or boat name available, please call for additional information.

Part No.	Diameter	Dish (B)	Knob
SSSW13.50-3	13-1/2"	10°	No
SSSW13.50-3-K	13-1/2"	10°	Yes
SSSW15.50-3	15-1/2"	10°	No
SSSW15.50-3-K	15-1/2"	10°	Yes
SSSWBANJO-CAP	Stainless steel blank cap		



## HEAVY DUTY 2 SPOKE - Straight Hole

Heavy duty cast 316 stainless steel hub with two spokes. Designed to fit 1" straight hole.

Part No.	Diameter	Dish (B)	Knob
SSSW15-6012001	15"	0°	No



## HEAVY DUTY 2 SPOKE - 3/4" Taper

Heavy duty cast 316 stainless steel hub with two spokes. Designed to fit 3/4" taper.

Part No.	Diameter	Dish (B)	Knob
SSSW15-6012002	15"	0°	No



# Aluminum Steering Wheels



## CAST ALUMINUM

Heavy duty cast aluminum, with finger grips, bright polished & clear anodized. An excellent choice for outside bridges in rugged sea conditions. Order washer and nut below.

Part No.	Diameter	Dish (B)	Knob
STWH13.00-ALUM	13"	10°	No
STWH15.50-ALUM	15-1/2"	10°	No
STWH13.00-ALUM-K	13"	10°	Yes
STWH15.50-ALUM-K	15-1/2"	10°	Yes



## STEERING WHEEL NUTS

A polished, appearance finished acorn style nut in various thread types. Order to fit your steering column. Nylon washer included.

Part No.	Thread
STWHNUT-112-13	1/2"-13 UNC
STWHNUT-112-20	1/2"-20 UNF
STWHNUT-12MM-175	M12x1.75
STWHNUT-518-18	5/8"-18 UNF



## FABRICATED ALUMINUM WHEEL

Fabricated aluminum-spokes and wheel, polished and anodized for a beautiful long-lasting finish. Complete with hub.

Part No.	Diameter	Dish (B)	Knob
STWH13.50-ALUM-K	13-1/2"	10°	Yes

# Sport Steering Wheels



## SPEED SPORT-Wood

Fabricated aluminum four spoke with the choice of three elegant wood finishes; Cherry, Hickory, Walnut. Complete with cap and insert.

Part No.	Diameter	Dish (B)
STWHW201-CHRY	13"	13°
STWHW201-HKRY	13"	13°
STWHW201-WLNT	13"	13.5°

# Sport Steering Wheels

## EUROPEAN CLASSIC - Wood/Aluminum

This three spoke layered wood wheel comes with highly polished aluminum, adding a classic look to any boat. Comes complete with cap.

Part No.	Diameter	Dish (B)
STWHW103	14-1/2"	18°



## SPEED SPORT - Composite/Aluminum

This three spoke covered wheel comes with aluminum accents at the 3, 6, and 9 hand positions of the wheel. Complete with cap.

Part No.	Diameter	Dish (B)
STWHW105	13"	8°



## TRADITIONAL ELEGANCE - Wood/ Chrome

Three spoke design, poly urethane hand grip. Chrome three hole accents. Complete with cap.

Part No.	Diameter	Dish (B)
STWHW102	13"	22°



# Sport Steering Wheels



## COMBI SPORT - Slotted

Aluminum three spoke with composite urethane and aluminum hand grips. Complete with cap.

Part No.	Diameter	Dish (B)
STWHW104	13"	17°



## COMBI SPORT - Plain

Plain aluminum three spoke with composite urethane and aluminum hand grips. Complete with cap.

Part No.	Diameter	Dish (B)
STWHW106	14"	17°

## ALUMINUM STEERING WHEEL HUB

Die cast aluminum CNC machine finished to insure precision fit on our steering wheels, with a black finish. Designed to fit all industry steering wheels.



Part No.
STWHHUB-ALB

## UNIVERSAL CAP ASSEMBLY

Aluminum universal replacement center cap for all Marine Hardware, Inc. sport steering wheels.



Part No.
STWHCAPASSY

# Maintenance, Repair, Operational (MRO)

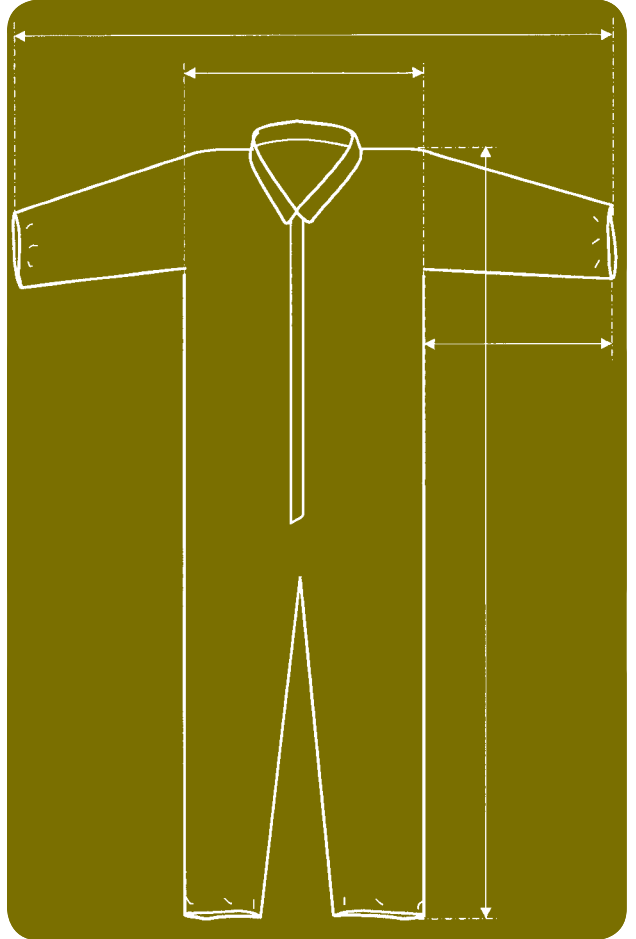
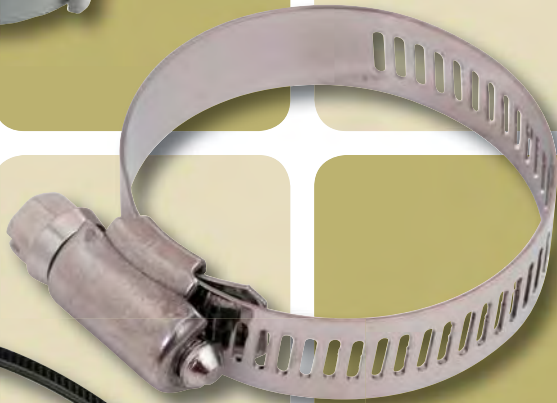

# Cover-Alls

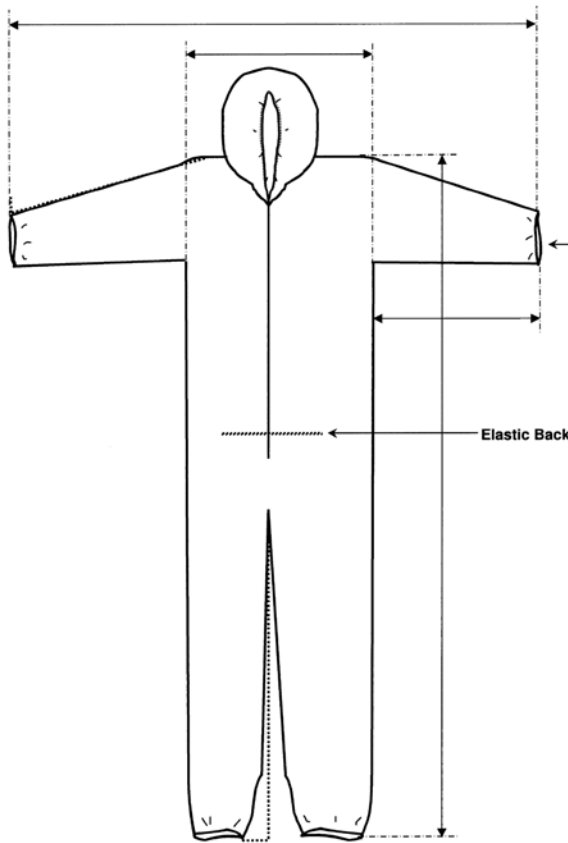

## DISPOSABLE COVER-ALLS-w/Hood

Marine Hardware,™ Inc.'s cover-alls are available in two grades, WE CR50 are breathable and WE CR60 are non-breathable.

Part No.	GMS	Size	Overall Length	Chest Width	Sleeve Length	Arm Length
WE CR50-HM	50	M	63.8"	24.4"	23.6"	72.4"
WE CR50-HL	50	L	65.7"	25"	24"	73.2"
WE CR50-HXL	50	XL	68.1"	27.2"	25"	77.2"
WE CR50-H2XL	50	2XL	70.5"	28.3"	25.2"	78.7"
WE CR50-H3XL	50	3XL	74"	29.9"	25.6"	81.1"
WE CR60-HXL	60	XL	68.1"	27.2"	25"	77.2"
WE CR60-H3XL	60	3XL	74"	29.9"	25.6"	81.1"
WE CR60-H4XL	60	4XL	78"	32.3"	26"	84.3"

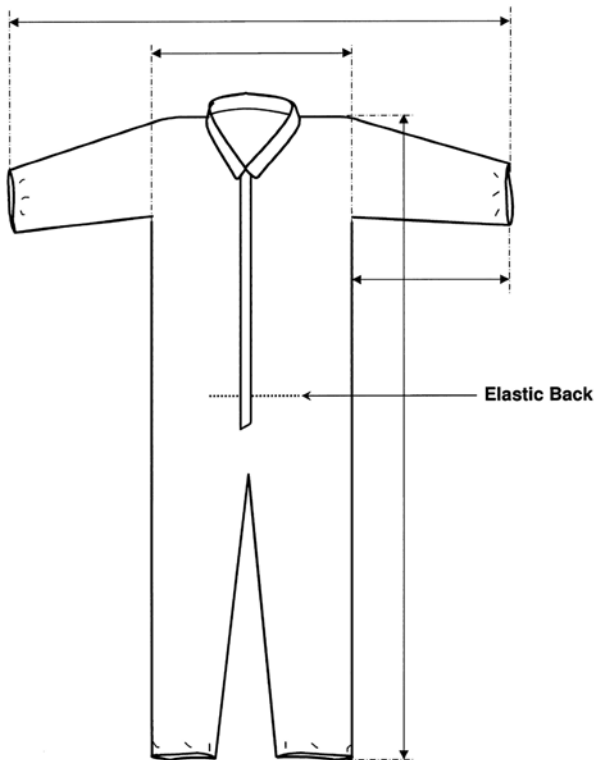

## DISPOSABLE COVER-ALLS-w/Collar

Marine Hardware,™ Inc.'s cover-alls are available in two grades, WE CR50 are breathable and WE CR60 are non-breathable.

Part No.	GMS	Size	Overall Length	Chest Width	Sleeve Length	Arm Length
WE CR50-CS	50	S	60.2"	22.8"	23.6"	70.1"
WE CR50-CM	50	M	63.8"	24"	23.6"	72.4"
WE CR50-CL	50	L	65.7"	25"	24"	73.2"
WE CR50-CXL	50	XL	68.1"	27.2"	25"	77.2"
WE CR50-C2XL	50	2XL	70.5"	28.3"	25.2"	78.7"
WE CR50-C3XL	50	3XL	74"	29.9"	25.6"	81.1"
WE CR50-C4XL	50	4XL	78"	32.3"	26"	84.3"
WE CR60-CM	60	M	63.8"	24"	23.6"	72.4"
WE CR60-CL	60	L	65.7"	25"	24"	73.2"
WE CR60-CXL	60	XL	68.1"	27.2"	25"	77.2"
WE CR60-C2XL	60	2XL	70.5"	28.3"	25.2"	78.7"
WE CR60-C3XL	60	3XL	74"	29.9"	25.6"	81.1"
WE CR60-C4XL	60	4XL	78"	32.3"	26"	84.3"
WE CR60-C5XL	60	5XL	79"	33"	29"	85"

# Tape Measures

## TAPE MEASURES

Part No.	Length	Case
TPMSM16-0.75	16'	Metal
TPMSM25-1.00	25'	Metal
TPMSSL10-0.62	10'	Plastic
TPMSSL16-0.75	16'	Plastic
TPMSSL25-1.00	25'	Plastic



## Nylon Wire Ties & Fasteners

### NYLON WIRE TIES w/Mounting Holes

Part No.	Nominal Length	Size WxL	Pcs/Bag	Bags/Ctn	Color
WRTS20001	4"	.10"x3.94"	100	250	Black
WRTS20002	6"	.142"x5.9"	100	250	Black
WRTS30001	8"	.189"x7.87"	100	250	Black
WRTS30002	12"	.31"x11.8"	100	250	Black

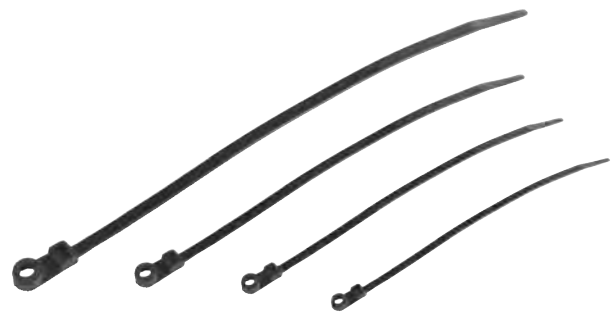

### NYLON WIRE TIES

Part No.	Nominal Length	Size WxL	Pcs/Bag	Bags/Ctn	Color
WRTS40001	5-3/4"	.189"x 6.3"	100	250	Black
WRTS40002	7"	.189"x 7"	100	250	Black
WRTS40003	8"	.189"x 7.87"	100	250	Black
WRTS40004	8"	.189"x 7.87"	100	250	White
WRTS40005	11"	.189"x 11"	100	250	Black
WRTS40006	14"	.189"x 13.75"	100	250	Black
WRTS40007	15"	.189"x15"	100	250	Black
WRTS40008	15-1/2"	.189"x 15.75"	100	250	White
WRTS40009	16"	.189"x 15.75"	100	250	Black



### TIE MOUNT

This unique part designed to be the least expensive solution to mounting tie wraps.

Part No.	Pad	Opening For Tie	Pcs/Bag
WRTS10001	1.135"x .76"	.400"x .76"	100



Loctite

### LOCTITE - 262

This 262 Loctite designed for all marine thread fasteners. Also works well on strut bearings and set screws on safety collars.

Part No.	Fluid Oz.
LOCT262-0.02	.02



# Miscellaneous



## COAXIAL SPEAKERS-White Grill

Our Marine Hardware,™ Inc. speakers are injected molded plastic with maximum UV resistance. Poly propylene diaphragms, and non-corrosive connectors make these waterproof and weather resistant in all environments. Special design covers are available upon request in both metal and plastic.

Part No.	Size	Watts
SPKR-CTS602-W	6"	150
SPKR-CTS652-W	6-1/2"	100



## SPEAKER GRILLS - Plastic

Part No.	Description	Color
GRILL-SPKR602W	Fits 6" Speaker	White
GRILL-SPKR652W	Fits 6-1/2" Speaker	White
GRILL-SPKR65BG	Fits 6-1/2" Speaker	Beige

## SPEAKER COVERS - Stainless Steel

Complete with frames, screen & 4 screws.

Part No.	Description
GRILL-SPKR1050SS-KIT	Grill kit for 10-1/2" speaker
GRILL-SPKR602SS-KIT	Grill kit for 6" speaker



# Hose Clamps

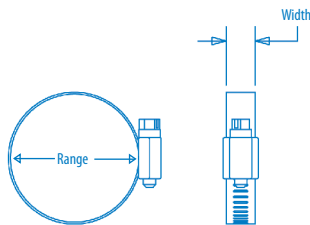

## HOSE CLAMPS

All clamps have stainless steel band and components.

Part No.	SAE	Width	Range
HSCP6D0616	MINI #4	5/16"	1/4"–5/8"
HSCP6D0822	MINI #6	5/16"	5/16"–7/8"
HSCP5D1022	#06	1/2"	3/8"–7/8"
HSCP5D1125	#08	1/2"	7/16"–1"
HSCP5D1427	#10	1/2"	1/2"–1-1/16"
HSCP5D1332	#12	1/2"	1/2"–1-1/4"
HSCP5D1832	N/A	1/2"	11/16"–1-1/4"
HSCP5D1838	#16	1/2"	11/16"–1-1/2"
HSCP5D1870	N/A	1/2"	11/16"–2-3/4"
HSCP5D2144	#20	1/2"	3/4"–1-3/4"
HSCP5D2751	#24	1/2"	1"–2"
HSCP5D3357	#28	1/2"	1-1/4"–2-1/4"

Part No.	SAE	Width	Range
HSCP5D4063	#32	1/2"	1-1/2"–2-1/2"
HSCP5D4670	#36	1/2"	1-3/4"–2-3/4"
HSCP5D5276	#40	1/2"	2"–3"
HSCP5D5782	#44	1/2"	2-1/4"–3-1/4"
HSCP5D6489	#48	1/2"	2-1/2"–3-1/2"
HSCP5D7095	#52	1/2"	2-3/4"–3-3/4"
HSCP5D76101	#56	1/2"	3"–4"
HSCP5D84108	#60	1/2"	3-1/4"–4-1/4"
HSCP5D64114	#64	1/2"	2-1/2"–4-1/2"
HSCP5D76127	#72	1/2"	3"–5"
HSCP5D92140	#80	1/2"	3-1/2"–5-1/2"
HSCP5D108152	#88	1/2"	4"–6"

# General Policies

---

**CREDIT:** Please call for a credit application, fill it out, sign, and fax back to Marine Hardware, Inc. We will notify you by email or return mail when your credit has been approved. General terms of sale are C.O.D., or cash in advance. We also accept Visa, MasterCard, Discover credit cards. With approved credit, terms are net (30) days from date of invoice. Any account unpaid after date due is subject to a service charge of 1.5% per month on the unpaid balance.

**TAXES:** All sales are made subject to Buyer's payment of all applicable State, County, City and Federal use sales and excise taxes. Any such tax may be billed to the buyer as part of the selling price, or may be separately billed at any time by the Seller, if the Seller is required by any taxing authority to collect or pay such tax.

**DISCREPANCIES:** All products leaving our warehouses are fully inspected. Please call Marine Hardware, Inc to report any discrepancies within (10) days of receipt.

**SHIPPING:** All products are shipped F.O.B. Seller's warehouse in Redmond, WA; Ormond Beach, FL; or Manistee, MI unless otherwise specified. Marine Hardware, Inc. does not warrant or insure any shipments for damage or loss. If you find damage, notify the carrier at the time of delivery. Do not refuse the shipment. The damage should be noted by the driver on the freight bill. It is your responsibility to file a claim for freight damage with the freight company.

**RETURNS:** If a product or item purchased is unsatisfactory or defective and you desire to return it you will need to obtain in advance a Return Goods Authorization number (RGA). Returns will not be accepted without a RGA. Custom products are not returnable. Products must be returned within 30 days of receipt. When returning goods the RGA number must be clearly marked on the box and a copy of the RGA must be included with the returned goods. You must prepay the return shipping charges and insure the shipment or accept the risk of loss or damage during shipment. The refund credit will not include any shipping and handling charges shown on your invoice, and you may be subject to a restock fee.

**MINIMUM ORDER:** We require a \$25 minimum order, not including shipping.

# Index

## Symbols

2" Underwater Halogen Lights, 23  
2" Underwater Xenon Light, 23  
2" Angle Neck, Deck Fills, 39  
2" Short Deck Fills, 39  
2 Stud Hollow Base Cleats, 31  
3/4" Taper Steering Wheel, 79  
4" Underwater Halide Lights, 22  
4" Underwater Halogen Lights, 22  
4" Underwater Xenon Lights, 22  
90° Deck Hinge, 50  
90° Fuel Line Fittings, 14

## A

### Access Hardware, 60-72

Adjustable Antenna Mount, 56  
Aluminum Steering Wheel Hub, 82  
Aluminum Steering Wheels, 80  
Anchor Chains, 53  
Anchor Swivels, 53  
Angle Base Deck Hinge, 50  
Angled Neck, Deck Fills, 39  
Antenna Mounts, 56  
Articulating Anchor Swivels, 53

## B

Ball Type Scuppers, 37  
Ball Valves, 6  
Banjo Style Steering Wheels, 79  
Barbed Mushroom, Thru-Hulls, 8  
Barrell Latches, 61  
Battery Box, 17  
Big Cap Replacement-Deck Fills, 40  
Bollards, 33  
Bow Anchor Rollers, 53  
Bow Chocks, 32  
Bow Eyes, 35  
Bow Plates, 35  
Butt Hinges, 64-65  
Butt Hinges-Stamped 67

## C

Cabinet Handles, 43  
Cabinet Latch, 61  
Captive Plug Garboard Drain, 18  
Captive Plug Oval Garboard Drain, 19  
Cast Aluminum Steering Wheel, 80  
Cast Hinges 63-66  
Cast Oval, Rod Holders, 44  
Cast Oval Ski Tows, 55  
Cast Rectangle, Rod Holders, 44  
Cast Rod Holders, 44

Chain Deck Pipe, 37  
Chain Stop, 53  
Chocks, 32  
Chrome Plated Hollow Base Cleat, 31  
Clamps, 20 & 86  
Clam Vents, 15  
Coaxial Speakers, 86  
Combi Sport-Plain Steering Wheel, 82  
Combi Sport-Slotted Steering Wheel, 82  
Common Head-Thru-Hulls, 8  
Composite/Aluminum Sport Steering Wheel, 81  
Cover-Alls, 84  
Cross-Pin Plug-Garboard Drains, 18  
Custom Cleats, 32  
Custom Designed Parts, 58  
Custom Drain Scuppers, 37  
Custom Hinges, 63 & 72  
Custom Lighted Logos-Letters, 25  
Custom Vent Grills, 57  
Cut Pipe Exhaust Outlets, 16

## D

Deck Fills, 38 & 39  
Deck Fills w/Key, 38  
**Deck Hardware, 28-60**  
Deck Hinge, 50  
Deck Hinges-Stamped, 67  
Deck Pipe, 37  
Deck Plates, 40  
Destroyer S.S. Steering Wheels, 78  
**Disclaimer of Warranty, 2**  
Disposable Cover-Alls w/Collar, 84  
Dive Ladder, 76  
Door Catch, 62  
Door Hinges-Cast, 63  
Door Stops, 62  
Drain Boot, 28  
Drain Flange, 11  
Drain Tubes, 19  
Drink Cup Holders, 41  
Disposable Cover-Alls w/Hood, 84  
Dual Horn Bollards, 33  
Dual Post Pull-Up Cleat, 28  
Dual Stack Drink Cup Holders, 41

## E

End Caps, Rod Holders, 45  
Equal Sided Door hinges, 63  
Euro Cleats, 30  
European Classic Steering Wheel, 81  
EVT Cleats, 30  
Exhaust Outlets, 16-17

Exhaust Systems, 16-17  
Exhaust Tee's, 17  
Expandable Plugs, 19  
Extended Mushroom-Thru-Hulls, 7  
Extension Pole-Antenna, 56  
External Fastened Grab Rails, 42

## F

Fabricated Aluminum Steering Wheel, 80  
Fabricated Hub & Spoke Steering Wheel, 78  
Faucet, 11  
Feet Mount Cleat-Euro Style, 30  
Female 90° Pipe-to-Hose Fittings, 13  
Fender Cleat-Pull Up, 29  
Fiddle Rails, 43  
Fittings, 51  
Fixed Anchor Swivels, 53  
Fixed Base Antenna Mount, 56  
Flange Faced Grab Handle/Rails, 42  
Flat Screen Bracket, 56  
Floating Dive Ladder, 76  
Flush Deck Tie Down, 61  
Flush Fuel Vents, 15  
Flush Fuel Vent w/ Tank Pressure Adapter, 15  
Flush Mount Hinges, 63 & 66  
Flush Mount Slam Latches, 60  
Flush Transom Eye, 34  
Folding Steps, 52  
Fuel Line Fittings, 14  
Fuel Vents, 15

## G

Garboard Drains, 18-19  
General Policies, 87  
Generator Exhaust Ports, 16  
Grab Handles, 42-43  
Grab Rails, 42-43  
Gunnel Caps, 52

## H

Half Oval Rub Rails, 52  
Halide Underwater Light-4", 22  
Halogen Underwater Lights-2", 23  
Halogen Underwater Lights-4", 22  
Hand Cap-Deck Fills, 39  
Hatch Pulls, 62  
Hatch Spring, 61  
Hawse Cleats, 36  
Hawse Pipes, 36  
Hawse Rings, 36

Heavy Duty 2 Spoke Steering Wheel, 79  
Heavy Duty Hollow Base Cleats, 31  
Heavy Duty Hub & Spoke Steering Wheel, 78  
Heavy Duty Steering Wheel Nuts, 78  
High Speed Water Pickups, 10  
Hinges, 64-72  
Hole Mount-Pull-Up Cleat, 29  
Hollow Base Cleats, 31  
Hose Clamps, 14,20 & 86  
Hose Vent, 57

## I

Interior Lights, 24

## K

Keel Plates, 34

## L

### Ladders, 74-76

Latches, 60-61  
LED Courtesy Lights, 24  
LED Strip Lights, 24  
Lifting Cleats, 34  
Lifting Rings, 34  
Lifting Rods, 34  
Lifting Systems, 34  
Lift Ring,s 62  
**Lighting, 22-25**  
**Limited Warranty, 2**  
Locking Style Latches, 60  
Loctite-262, 85  
Long Pawl, 60  
Low Volume Water Pick-Up, 9

## M

Magnetic Door Catch, 62  
Male 90° Pipe-to-Hose Fittings, 13  
Metal Cased Tape Measures, 85  
Miscellaneous, 86  
**MRO, 84-86**  
Multi-Port Sea Strainers, 12  
Multi Port, Thru-Hulls, 11

## N

No Bolt Rod Holders, 46  
Nylon Exhaust Outlets, 17  
Nylon Wire Tie Mount, 85  
Nylon Wire Ties, 20 & 85

## O

Oval Garboard Drain, Captive Plug, 19  
 Oval Head, Stamped Rod Holders, 45  
 Oval Scuppers, 37

## P

Pad Eyes, 50  
 Pelican Hooks, 51  
 Piano Hinges, 70  
 Pickup Screens, 10  
 Pipe-to-Hose Fittings, 13  
 Pipe Nipples, 10  
 Plastic Cased Tape Measures, 85  
 Plastic Rod Holder, 45  
 Plug Style Garboard Drains, 18  
 Plug Style Garboard Drains w/O Ring, 18

### Plumbing, 6-20

Pull-Up Cleats, 28,29  
 Pull-Up Fender Cleat, 29  
 Pull-Up Ski Pylon, 54  
 Pull Pin, 51  
 Pulls, 62

## R

Radius Base Deck Hinges, 50  
 Rail Fittings, 48-49  
 Recessed Lifting Ring, 62  
 Rectangle Base, Rail Bases, 46  
 Rectangle Slam Latches, 60  
 Refrigerator Vent, 57  
 Removable Pin w/Toggle, 51  
 Replacement Cap, Deck Fill, 40  
 Replacement Cap, Steering Wheel, 78  
 Replacement Parts, Deck Fills, 40  
 Replacement Parts, Sea Strainers, 12  
 Retractable Fender Cleat, 29  
 Retractable Ski Pylon, 54  
 Ringed Cup Holders, 41  
 Rod Holder End Caps, 45  
 Rod Holders, 45-46  
 Rope Deck Pipe, 37  
 Round Bases Rail Fittings, 48-49  
 Round Hinge, 65  
 Round Seacocks, 6  
 Rub Rails, 52

## S

Sampson Post, 55  
 Scuppers, 37  
 Sea Strainer Replacement Parts, 12  
 Sea Strainers, 12

Seat Hinges, 70-71  
 Service Parts, 4  
 Short Deck Fills, 39  
 Short Mushroom, Thru-Hull, 7  
 Single Head Bollard, 33  
 Single Post Pull-Up Cleat, 28  
 Single Stack Drink Cup Holders, 41  
 Skene Bow Chocks, 32  
 Ski Pylons, 54  
 Ski Tows, 55  
 Slam Latches, 60  
 Scissor Hinges, 66  
 Spacers, 60  
 Speaker Covers, 57 & 86  
 Speaker Grills, 86  
 Speakers, 86  
 Speed Sport-Wood-Steering Wheels, 80  
 Speed Sport Steering Wheel, 81  
 Sport Steering Wheels, 80-82  
 Spring Hatch Opening, 61  
 Stainless Clad, Thru-Hull, 9  
 Stainless Steel/Plastic Thru-Hull, 9  
 Stainless Steel Clad Drain Tube, 11  
 Stainless Steel Steering Wheels, 78-79  
 Stamped, Weldable Rail Bases, 46  
 Stamped Hinges, 67-69  
 Stamped Rod Holders, 45  
 Standard Mushroom, Thru-Hulls, 7  
 Standard Pawl, 60  
 Stand Offs, 51  
 Steering Wheel Cap Assembly, 82  
 Steering Wheel Hub, 82  
 Steering Wheel Nuts, 80  
 Steering Wheel Nuts-S.S., 78  
**Steering Wheels, 78-82**  
 Steps, 52  
 Stern Eyes, 35  
 Stock Hinges, 63  
 Straight Chocks, 32  
 Straight Fuel Fittings, 14  
 Straight Hole Steering Wheel, 79  
 Straight Pipe-to-Hose Fittings, 13  
 Strap Hinges, 64  
 Strip Lights-LED, 24  
 Stud Mount, Grab Handles, 43  
 Stud Mount, Grab Handles/Rails, 42  
 Stud Mount Cleat-Euro Style, 30  
 Stud Mount Pull-Up Cleat, 29

## T

T-Handle Garboard Drains, 19  
 Table of Contents, 3

Take Apart Hinge, 63  
 Tape Measures, 85  
 Tees, Rail Fittings, 49  
 Telescoping Ladders, 75  
 Thru-Hull Installation Tools, 9  
 Thru-Hulls, 7-11  
 Tie-Down, 61  
 Tie Mount, 85  
 Toggle Cap Deck Fills, 38  
 Toggle Replacement Cap-Deck Fill, 40  
 Top Caps, 50  
 Top Fittings, 50  
 Top Slides, 50  
 Top View-Sea Strainers, 12  
 Traditional Elegance Steering Wheel, 81  
 Transom door Latch, 61  
 Transom Step, 52  
 Trapezoid Head, Stamped Rod Holder, 45  
 Tri-Angle Seacocks, 6  
 Turnbuckle, 52  
 Turn Down Exhaust Outlets, 16  
 TV Bracket, 56  
 Two Horn Fabricated Bollards, 33

## U

Under Swim Platform Ladder, 74  
 Underwater Halide Light, 22  
 Underwater Halogen Lights-2", 23  
 Underwater Halogen Lights-4", 22  
 Underwater Lights, 22 & 23  
 Underwater Xenon Light-2", 23  
 Underwater Xenon Lights-4", 22  
 Unequal Sided Door Hinges, 63  
 Universal Steering Wheel Cap Assembly, 82  
 Universal Swivel Mount, Sea Strainers, 12  
 Upholstery Hinge, 63-65  
 Upholstery Hinge-Stamped, 67  
 Upholstery Hinges, Stamped, 68 & 69

## V

Valves, 6  
 Vector Lifting Eye, 34  
 Vent Grills, 57  
 Vertical Ski Tow Rings, 55

## W

**Warranty, 2**  
 Washdown Deck Plate, 40  
 Washdown Faucet, 11  
 Water-Jacketed Underwater Light, 23  
 Weldable Rail Bases, 46

Wire Ties, 20

## X

Xenon Underwater Lights-4", 22

## Z

Zip Tie Mount, 85  
 Zip Ties, 20 & 85

## Working with partners around the world



### Redmond, WA

Toll Free Phone: 800-526-5971  
Local Phone: 425-883-0651  
Fax: 425-869-1232

Office Hours:  
8:00 am - 5:00 pm PST M-F

Shipping Address:  
14560 NE 91st Street  
Redmond, WA 98052

Mailing Address:  
PO Box 3099  
Redmond, WA 98073-3099

### 2016

### Ormond Beach, FL

Phone: 386-677-0687  
Fax: 386-676-3869

Office Hours:  
8:00 am - 5:00 pm EST M-F

5 Aviator Way  
Ormond Beach, FL 32174

Email:  
[info@marinehardware.com](mailto:info@marinehardware.com)

[www.marinehardware.com](http://www.marinehardware.com)

*Quality materials make it strong ... Our designs make it better.*